

10 MHz – 24 GHz Dual Channel RF Signal Generator

Features

- Amplitude calibration from 10MHz – 20GHz
- Open source Labview GUI software control via USB
- Run hardware functions with or without a PC
- 32-bit ARM processor on board
- Two channel frequency, phase and amplitude control
- Quadrature (or other phase) LO signal generation
- 0.1Hz frequency resolution
- 0.01 degree phase control on each channel
- 100uS RF lock time standard
- Up to +20dBm output power
- 0.01dB amplitude resolution
- Over 50dB of power control
- Absolute power display on Software GUI
- 10MHz – 100MHz external reference input
- Selectable 10 or 27 MHz internal reference output
- 2.5ppm internal reference accuracy
- Internal and external FM, AM, Pulse Modulation
- Pulsed FMCW Chirp
- External sweep, step and modulation trigger
- 500 point frequency and amplitude hop table
- Dual channel frequency and amplitude lock
- Channel enable / disable saves energy
- 5 Ultra low noise linear regulators on board
- 3.0 X 2.15 inches not including RF connectors
- USB or UART control via USB-C connector
- Operation from 20GHz to 24GHz is uncalibrated

Overview Description

The Windfreak Technologies SynthHD PRO is a 10 MHz to 24 GHz dual channel software tunable RF signal generator and frequency sweeper controlled and powered by a device running Windows or Android via its USB port. The SynthHD PRO's dual independent channels can be configured to run as two different frequencies, or the same frequency with different phases. This allows its use in antenna beam steering applications or quadrature signal generation commonly used in image reject frequency conversion.

The SynthHD PRO also has nonvolatile on-board flash memory so it can be programmed to fire up by itself on any frequency, power, sweep or modulation setting (and combinations thereof) to run without a PC in the field. This makes for a highly mobile, low power and light weight solution for your RF signal generation needs.

Applications

- Wireless communications systems
- Antenna beam steering
- Quadrature LO for image reject mixers
- RF and Microwave radios
- Software Defined Radio (SDR)
- Radar including FMCW
- Automated Test Equipment (ATE)
- EMC - radiated immunity pre-compliance testing
- Electronic Warfare (EW) and Law Enforcement
- IP3 Two Tone Intermodulation Distortion Testing
- Quantum device research
- Plasma physics

SynthHD PRO Functional Diagram

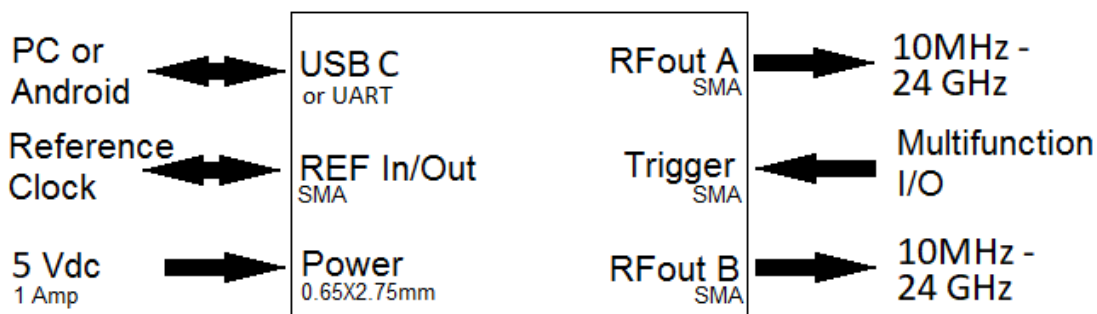

Contents

1	USB / UART WARNING	2
2	Characteristics	3
2.1	Electrical Characteristics	3
2.2	Thermal Operating Characteristics	4
3	Typical Performance	4
3.1	RF Output Power.....	4
3.2	RF Output Harmonic Content	7
3.3	RF Port to Port Isolation	8
3.4	Integer Boundary Spurs.....	10
3.5	Phase Noise and Jitter	10
3.6	Intermodulation Distortion after an External Wilkinson Combiner	14
3.7	Performance over Temperature	15
4	Device Information	17
4.1	Mechanical Dimensions	17
4.2	Product Renderings.....	18

1 USB / UART WARNING

The SynthHD Pro v2 was designed to work with, and ships with, a USB 2 cable. Use a USB 3 cable only when tapping into the UART signals for 3.3V COM port control of the SynthHD Pro with your own microcontroller circuit. Using a USB 3 cable attached to a USB 3 port on a PC may have unknown consequences as the PC is not designed to see the SynthHD UART signals and vv. See UART app note for UART usage instructions.

2 Characteristics

2.1 Electrical Characteristics

Characteristic	Notes	Min.	Typ.	Max.	Unit
Supply Voltage	Suggested 2A minimum	4.7	5	5.5	V
Supply Current	420mA per channel		900	1200	mA
Standby Supply Current	Both RF channels OFF		70		mA
RF Output Frequency Range		10	-	24000	MHz
Calibrated Frequency Range		10		20000	MHz
RF Output Power Maximum	See graph	6	17	20	dBm
RF Output Power Minimum	See graph		-40		dBm
RF OFF Output Power	100% shutdown of RF section			-90	dBm
RF Frequency Resolution	Default is 100Hz selectable by Channel Spacing Setting	0.1			Hz
RF Output Power Resolution		0.01			dB
RF Phase Resolution	** See note 1	0.01			°
RF Output Impedance			50		Ω
Internal Reference Frequency	Selectable		10 or 27		MHz
Internal Reference Tolerance			2.5		ppm
External Reference Frequency	Keep phase comparator less than 100MHz	10	-	100	MHz
External Reference Level	Keep below 3.3Vpp		+10		dBm
Trigger	Internally pulled up	-0.3		3.3	V
UART		-0.3		3.3	V

Note 1: Phase tuning speed, phase resolution and carrier frequency are inter-related. Phase tuning speed slows as RF carrier frequency and Channel Spacing settings decrease. Smaller Channel Spacing will have higher phase and frequency resolutions but slower phase tuning speed. Going below 100MHz carrier with smaller Channel Spacing than 100Hz may be prohibitively slow and/or erratic.

2.2 Thermal Operating Characteristics

Description	Notes	Min	Max	Unit
Operating Temperature	Without airflow or heatsinking	-40	30	°C
Operating Temperature	Query internal temperature sensor with software and keep below 75C with airflow, heat sinking or limited duty cycle.	-40	75 Internal	°C

3 Typical Performance

3.1 RF Output Power

The typical output power (per channel) of the SynthHD PRO is shown below. This graph is of raw unlevelled operation at both the maximum and minimum gain settings of the output variable gain section. Gain is set via dBm power commands allowing output power levels anywhere in the range between the minimum and maximum levels shown below. RF port power and frequency can be set independent of each other. Power levels are settable in 0.01dBm increments. On board calibration is attained through a look up table for each channel. Device calibration is performed at the factory and stored in onboard flash memory. Calibration is good from 10MHz to 20GHz. Operation from 20GHz to 24GHz is uncalibrated and unspecified. All parts of the signal chain have high quality voltage regulation, and the D/A's driving the VGAs have a 1% voltage reference controlling their outputs.

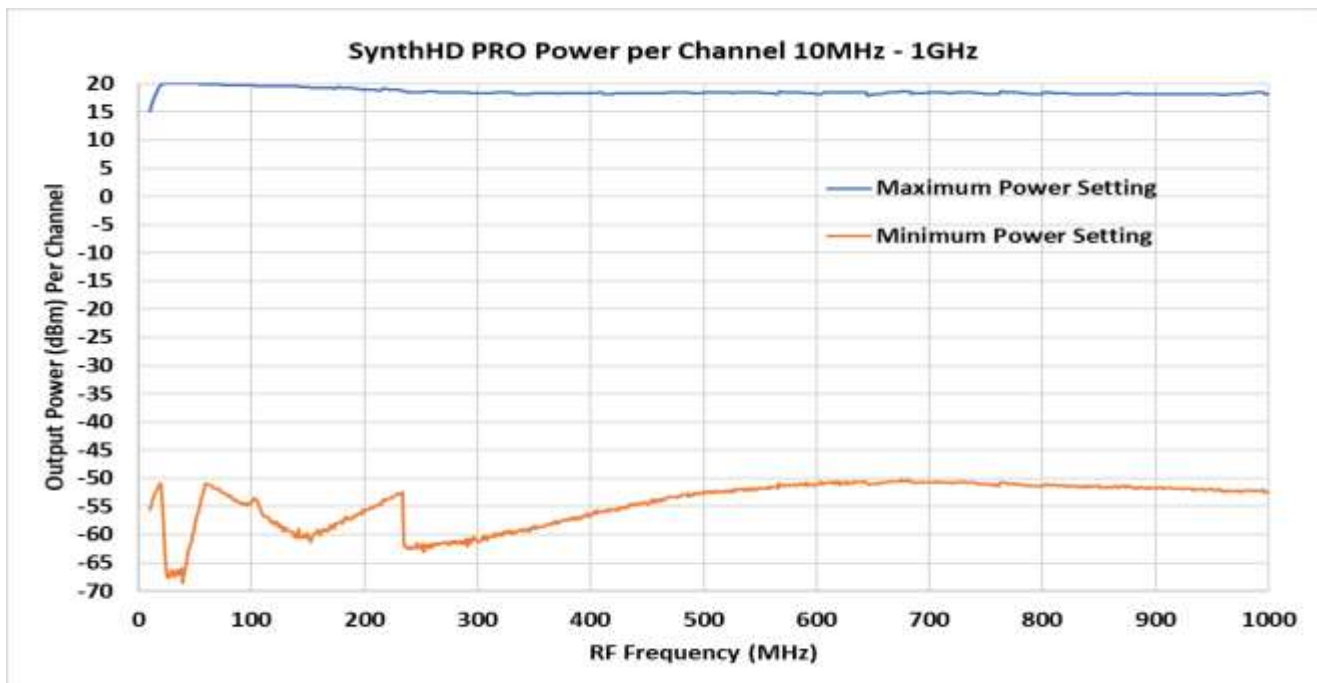

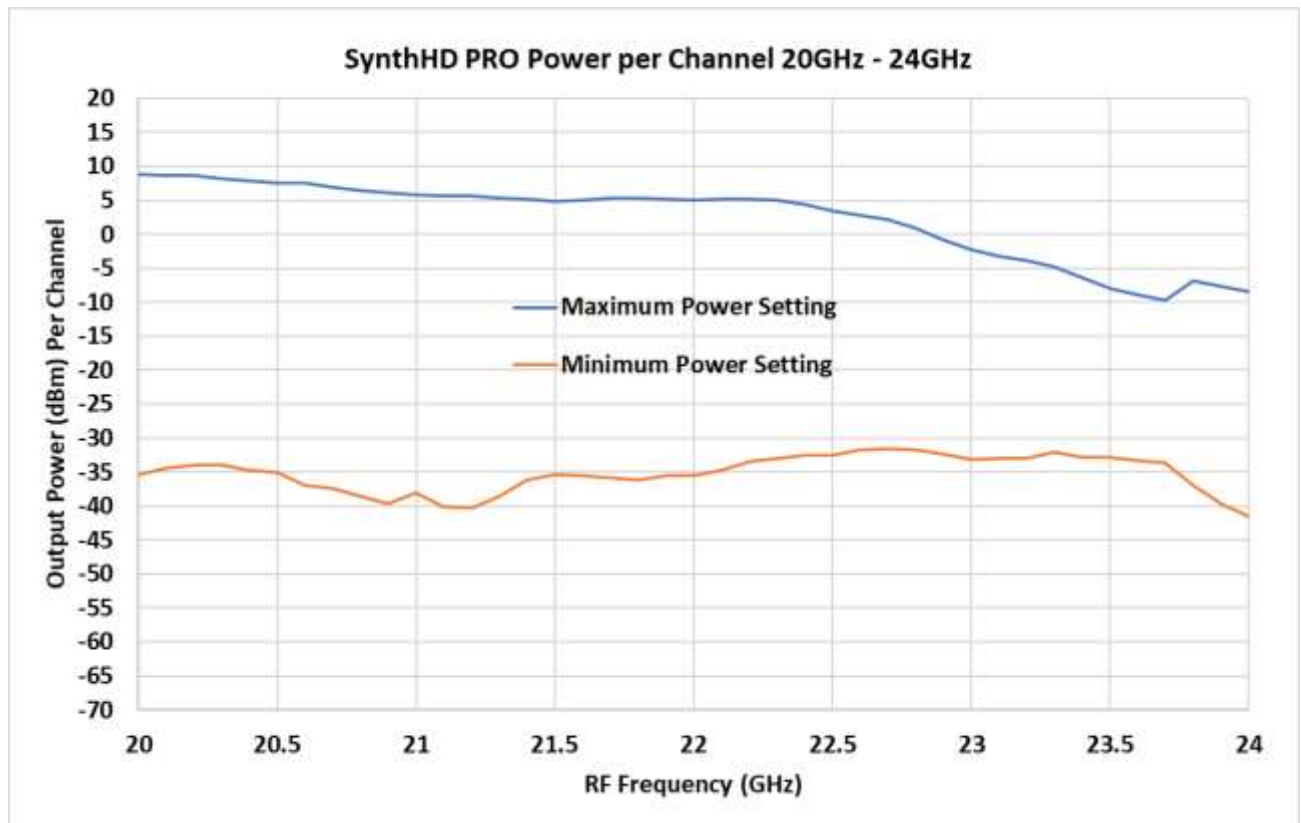
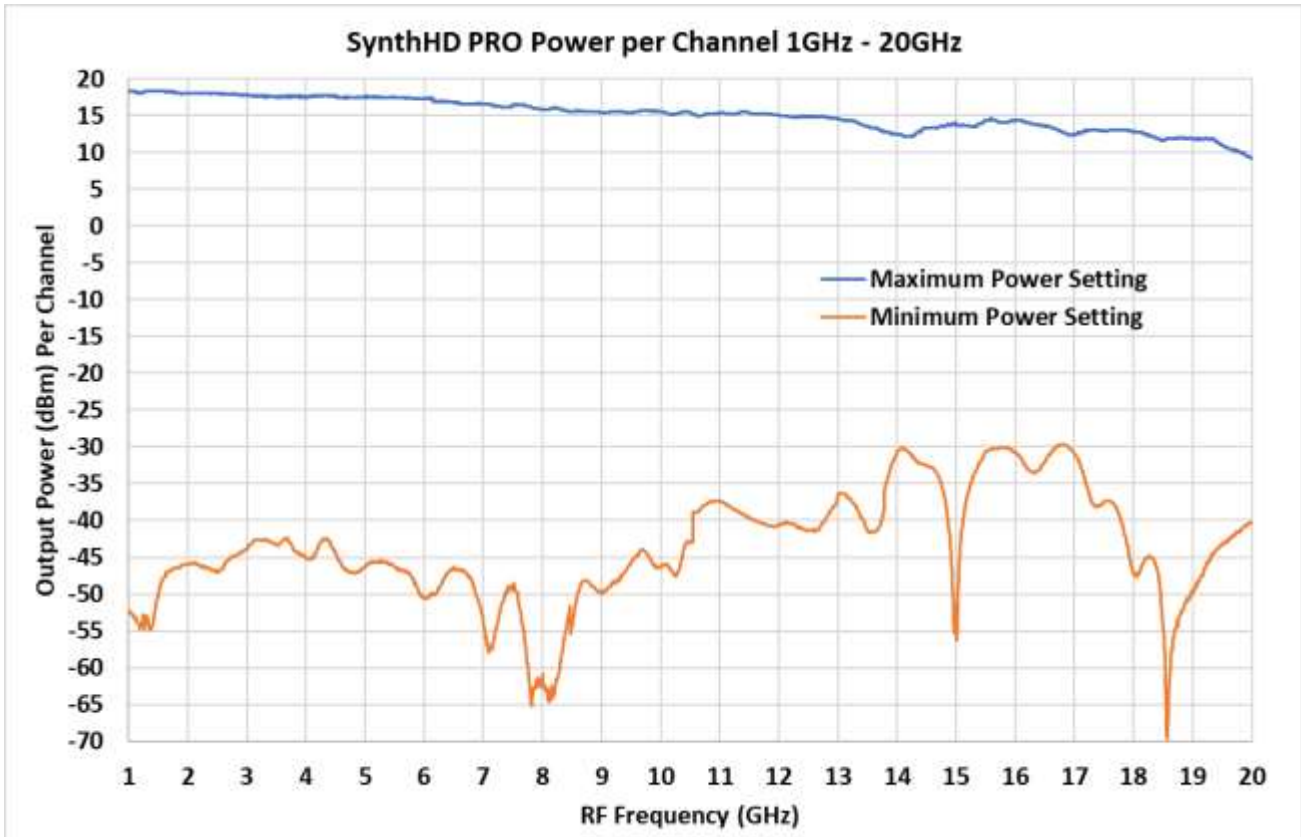

Typical SynthHD PRO Calibration

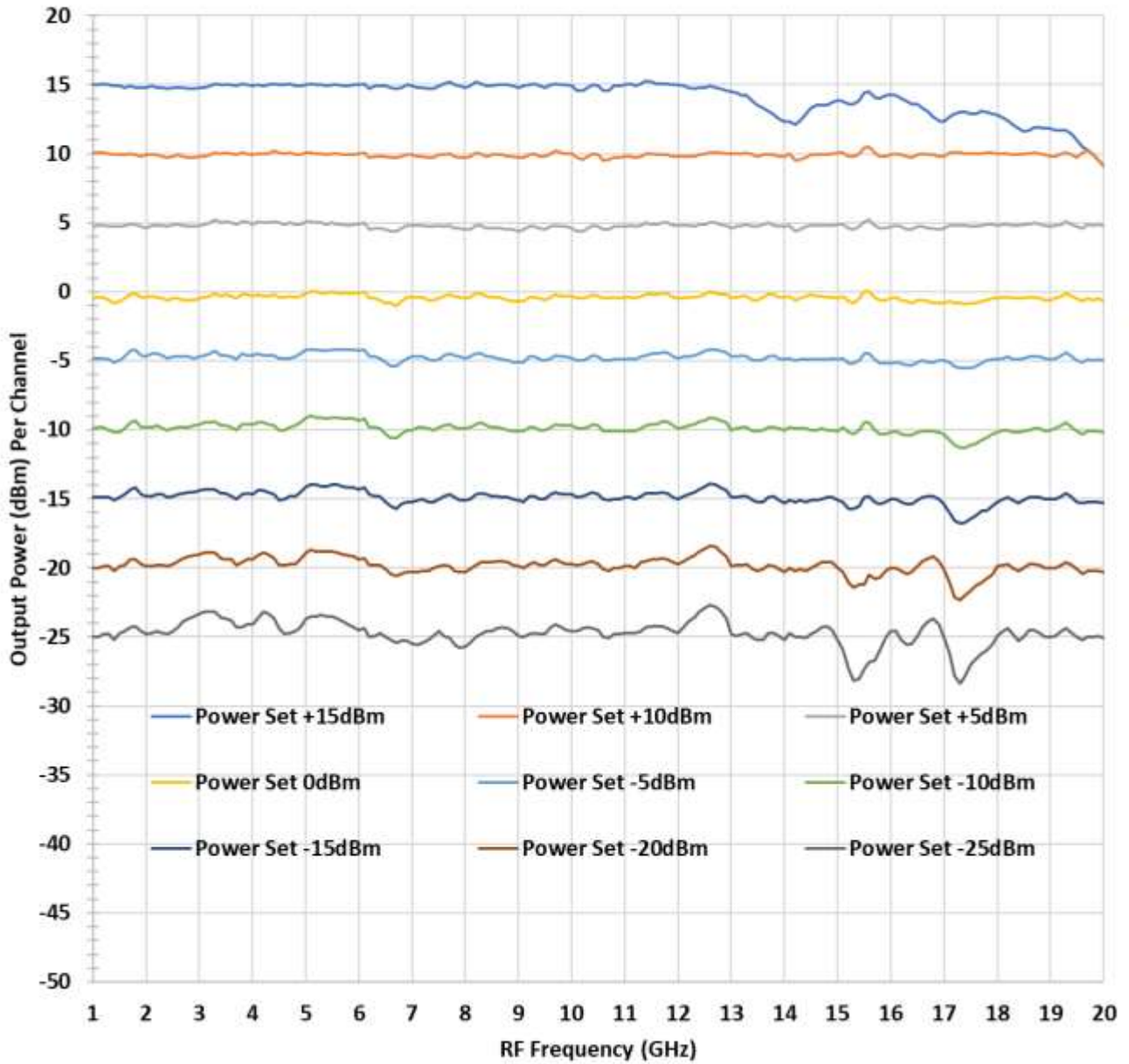

Note: +15dBm setting hitting max power limit above 12GHz

3.2 RF Output Harmonic Content

The typical SynthHD PRO harmonic distortion is shown below for the second and third harmonics. Also shown is a subharmonic created when generating fundamental frequencies above 15GHz. All frequencies above 15GHz are generated with an RF doubler. This data is taken at a leveled fundamental power of 0dBm.

If lower harmonic and subharmonic levels are needed, Windfreak Technologies suggest the use of low cost SMA filters from Crystek and Minicircuits.

Example: Crystek Lowpass Filter – many cutoff frequencies, 1GHz example: CLPFL-1000, \$25

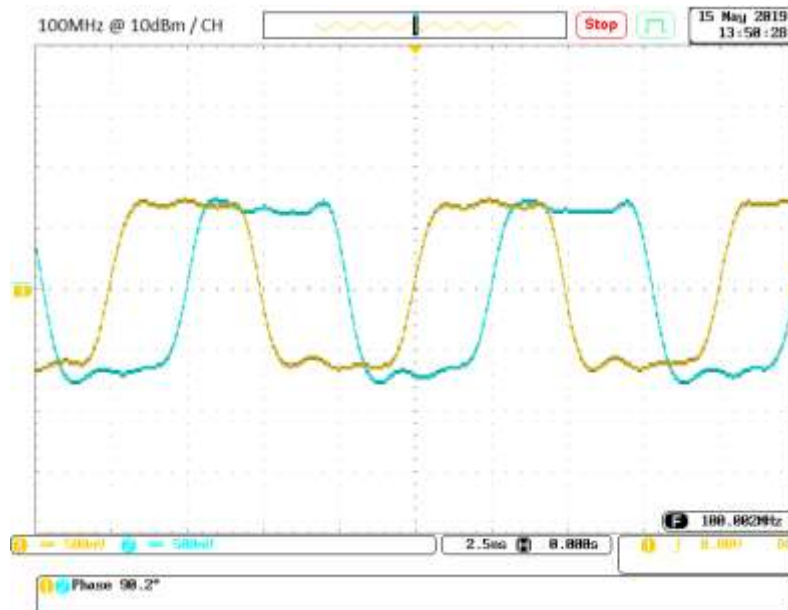
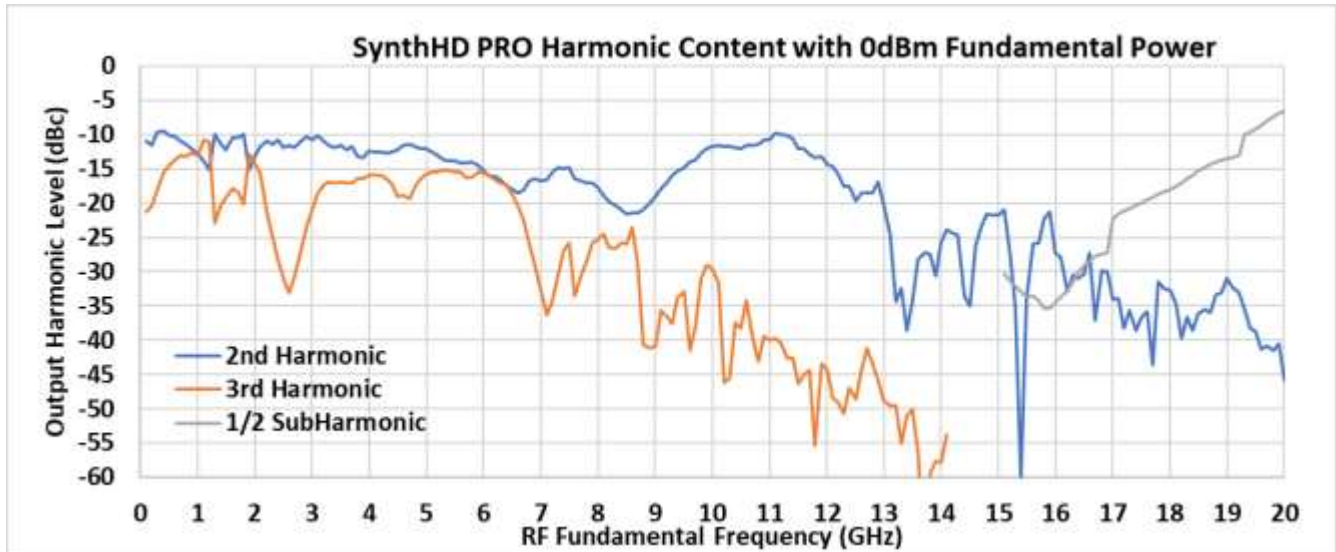

Typical 100MHz waveform, both channels adjusted to 90 degrees offset (500MHz scope).

3.3 RF Port to Port Isolation

Port to port isolation is shown below with both channels at 0dBm output power. One trace is taken with a 3MHz offset between channels. The other trace is taken with a 20KHz offset between channels. The 20KHz offset places each signal within each other's loop bandwidth and the leakage modulates each other's VCO control voltages where loop gain is high. Offsets inside the loop bandwidth will have worse isolation. The below data is taken with both PLL_ICP settings at 15.

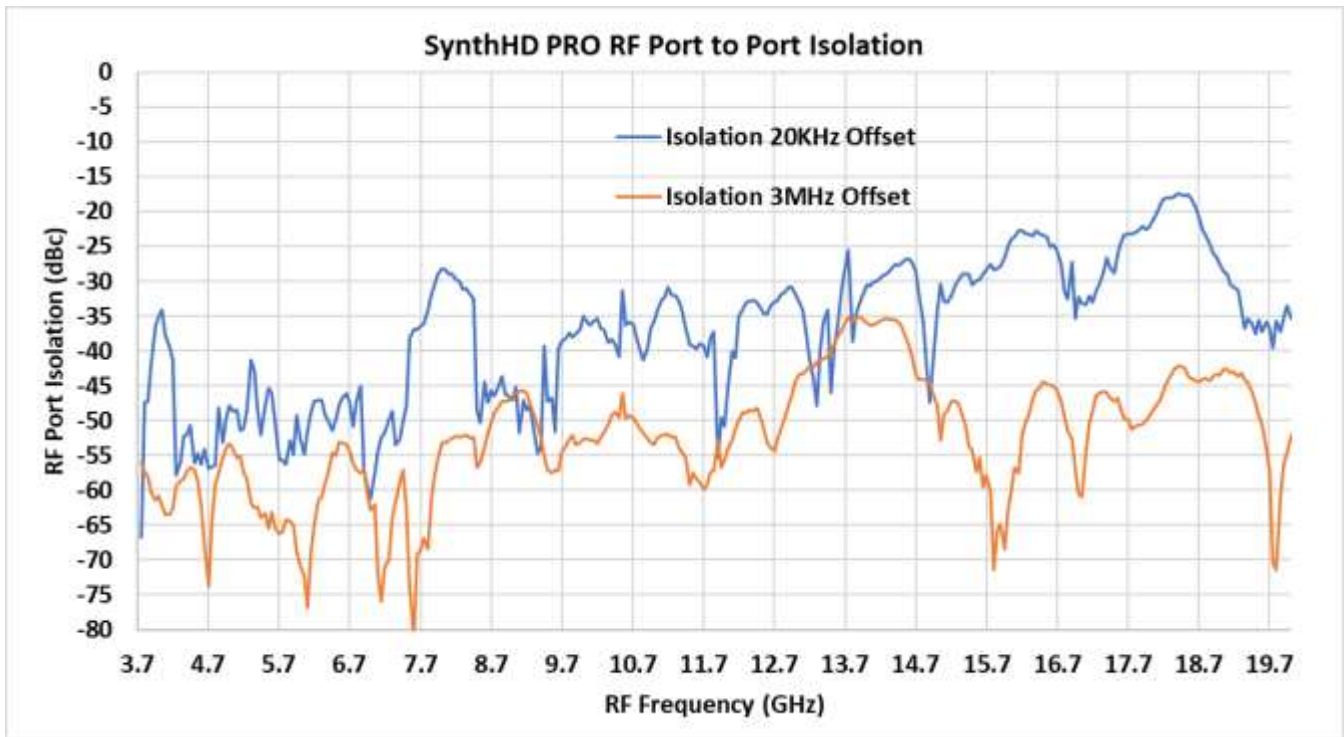

Note: Performance below 3.7 GHz continues to trend downward.

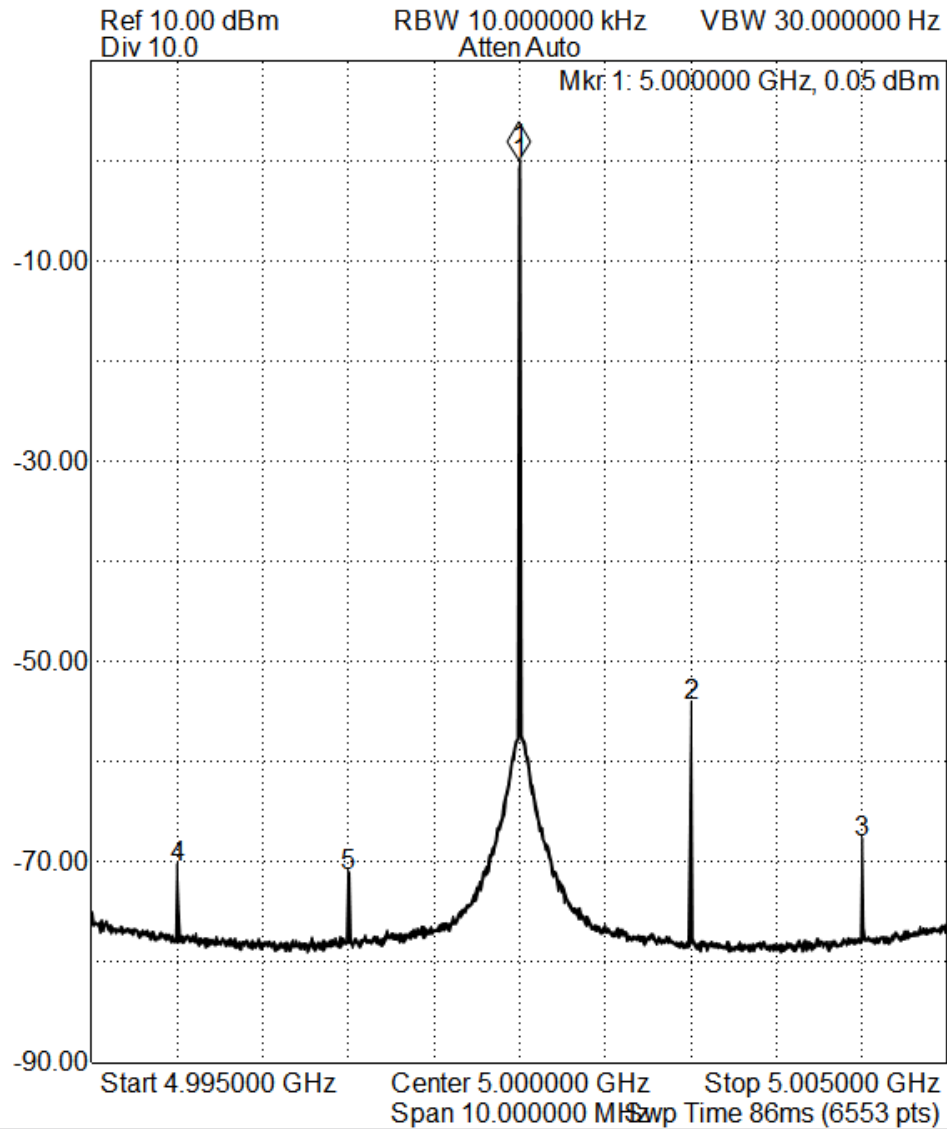

Peak Table

Enabled

Threshold

Excursion

Sort Order

	Frequency	Amplitude	Delta Freq	Delta Ampl
1	5.000000 ...	0.05 dBm	0.000000 Hz	0.00 dB
2	5.002001 ...	-53.94 dBm	2.000427 ...	-53.99 dB
3	5.004001 ...	-67.60 dBm	4.000854 ...	-67.65 dB
4	4.996003 ...	-70.17 dBm	-3.997803...	-70.22 dB
5	4.998000 ...	-70.90 dBm	-2.000427...	-70.95 dB

5GHz Port to Port Isolation Spectrum with +1MHz Offset

Note: The plot above shows the conducted port at 5.0 GHz. The terminated port is set at 5.001 GHz. The spur location is at a 2MHz offset since the SynthHD Pro uses an RF divide by 2 circuit to achieve 5GHz. As the RF frequency decreases, the isolation spurs move out, until they are eventually outside of the loop bandwidth and thus significantly attenuated.

3.4 Integer Boundary Spurs

A mechanism for in band fractional spur creation in all fractional PLL's is the interactions between the RF VCO frequency and the internal 27MHz, internal 10MHz or arbitrary external reference frequency. When these frequencies are not integer related, spur sidebands appear on the VCO output spectrum at an offset frequency that corresponds to the difference in frequency between an integer multiple of the reference and the VCO frequency. These spurs are attenuated when outside the loop filter which is 12KHz wide. By having two selectable internal reference frequencies of 10MHz and 27MHz the problem is eliminated by switching reference frequencies when working around a boundary.

Example if using the SynthHD PRO 27MHz internal reference: For the fundamental VCO range of 3400MHz to 6800MHz the first integer boundary happens at $27\text{MHz} \times 126 = 3402\text{MHz}$, the next at $27\text{MHz} \times 127 = 3429\text{MHz}$ and every 27MHz thereafter up to 6777MHz. Above and below the fundamental VCO band the spacing will be affected by the RF doubler or RF divider respectively. If the desired VCO operating frequency is 3402.01MHz this would give spurs 10KHz on either side of the carrier that may be unacceptable. In this case, using the 10MHz reference would be suggested since its closest integer boundary is at 3400MHz. Spurs 2MHz away will be attenuated to satisfactory levels by the loop filter.

3.5 Phase Noise and Jitter

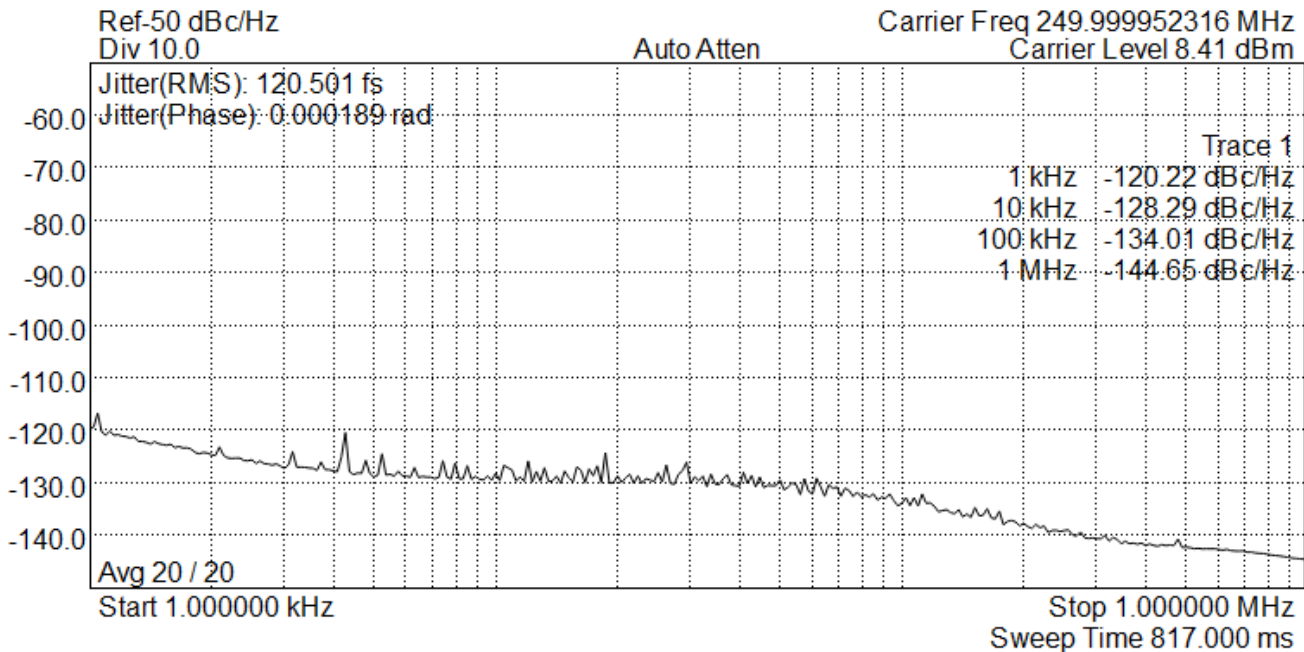

250MHz Phase Noise

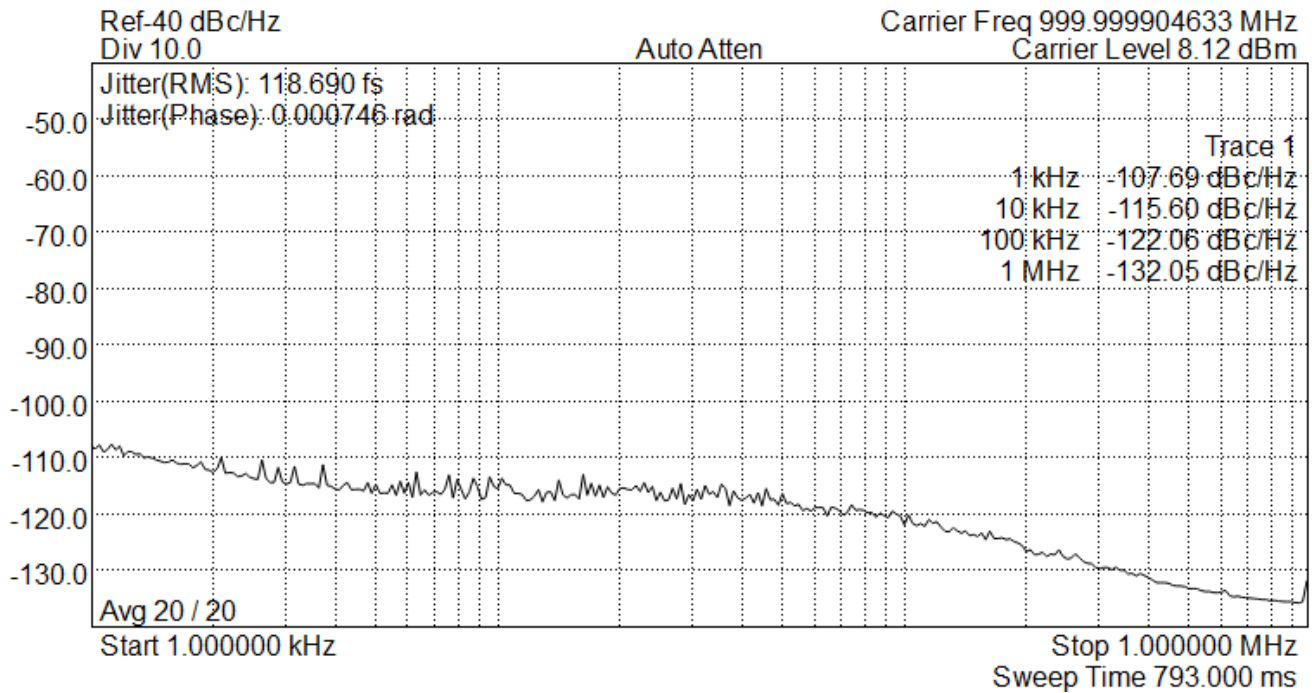

1GHz Phase Noise

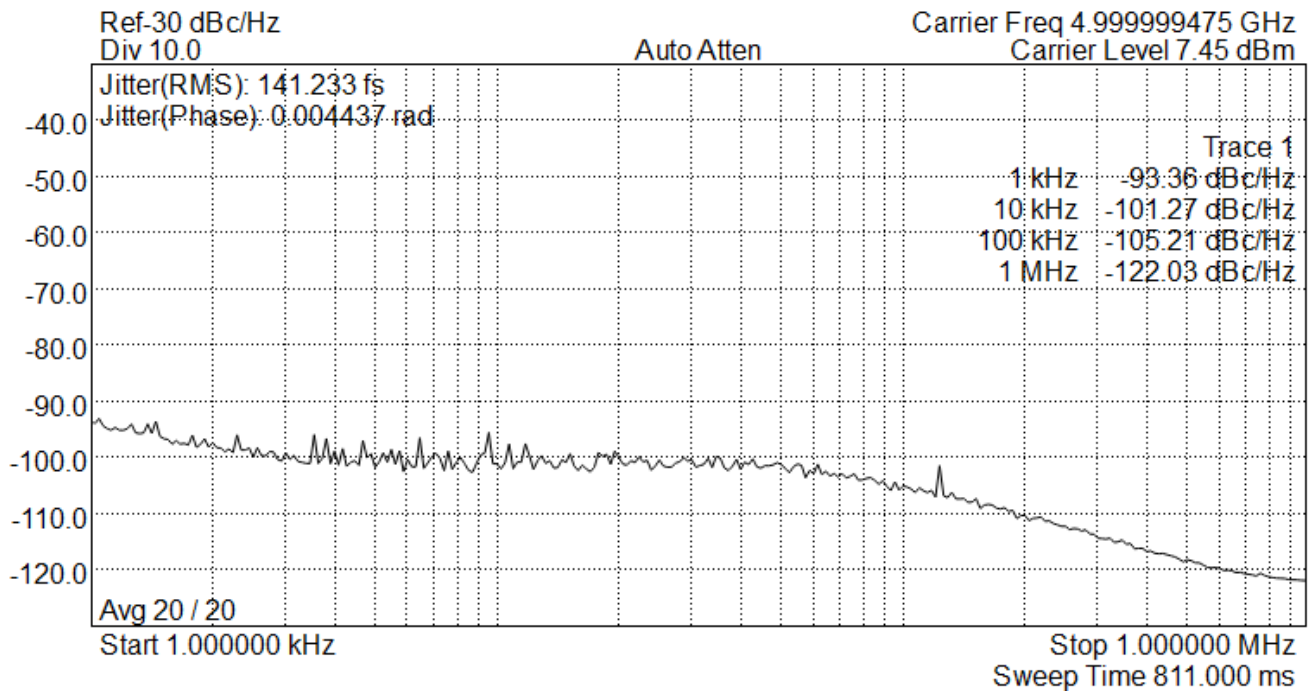

5GHz Phase Noise

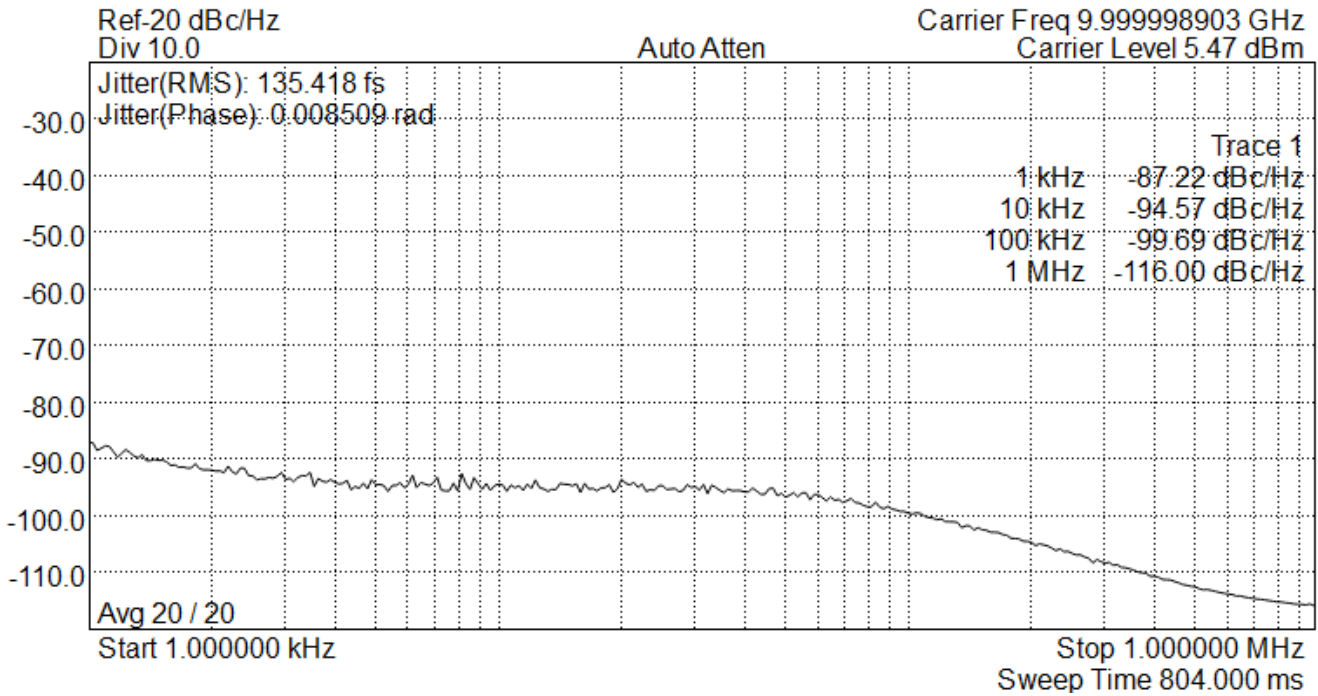

10GHz Phase Noise

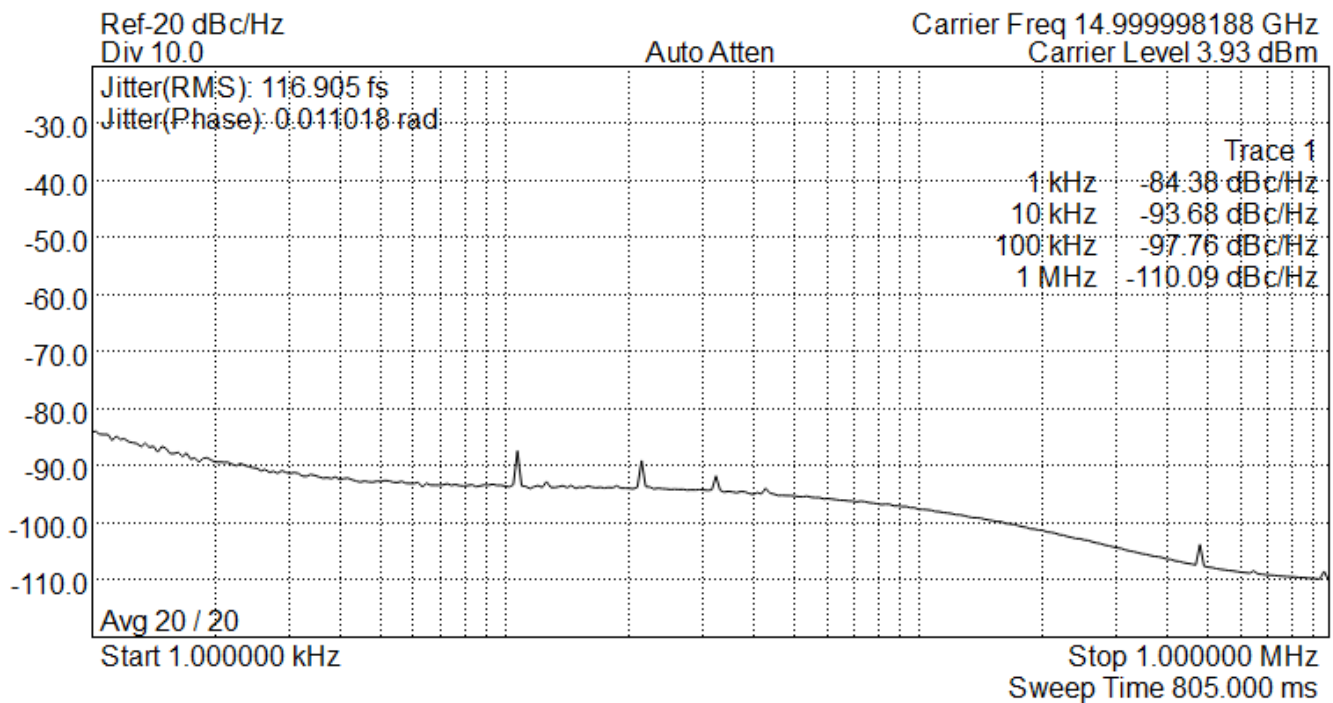

15GHz Phase Noise

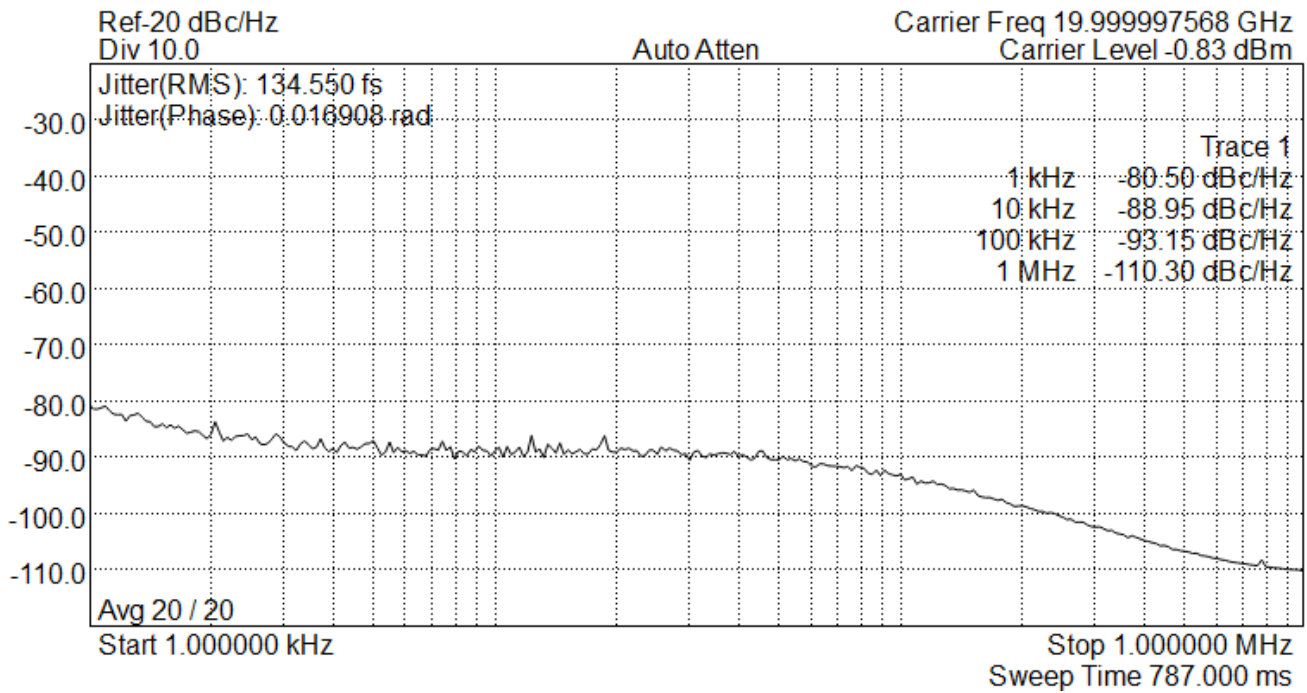

20GHz Phase Noise

3.6 Intermodulation Distortion after an External Wilkinson Combiner

It's possible to lock both channels in both frequency and amplitude for easy tuning during IMD testing of IP3 in passive and active components. The plot below shows two tones combined with a YL-70 0.5-2.0 GHz KL combiner that has roughly 20dB of isolation between ports. The tones are centered at 1GHz and separated by 1MHz. This method will allow for IP3 testing below roughly +40dBm.

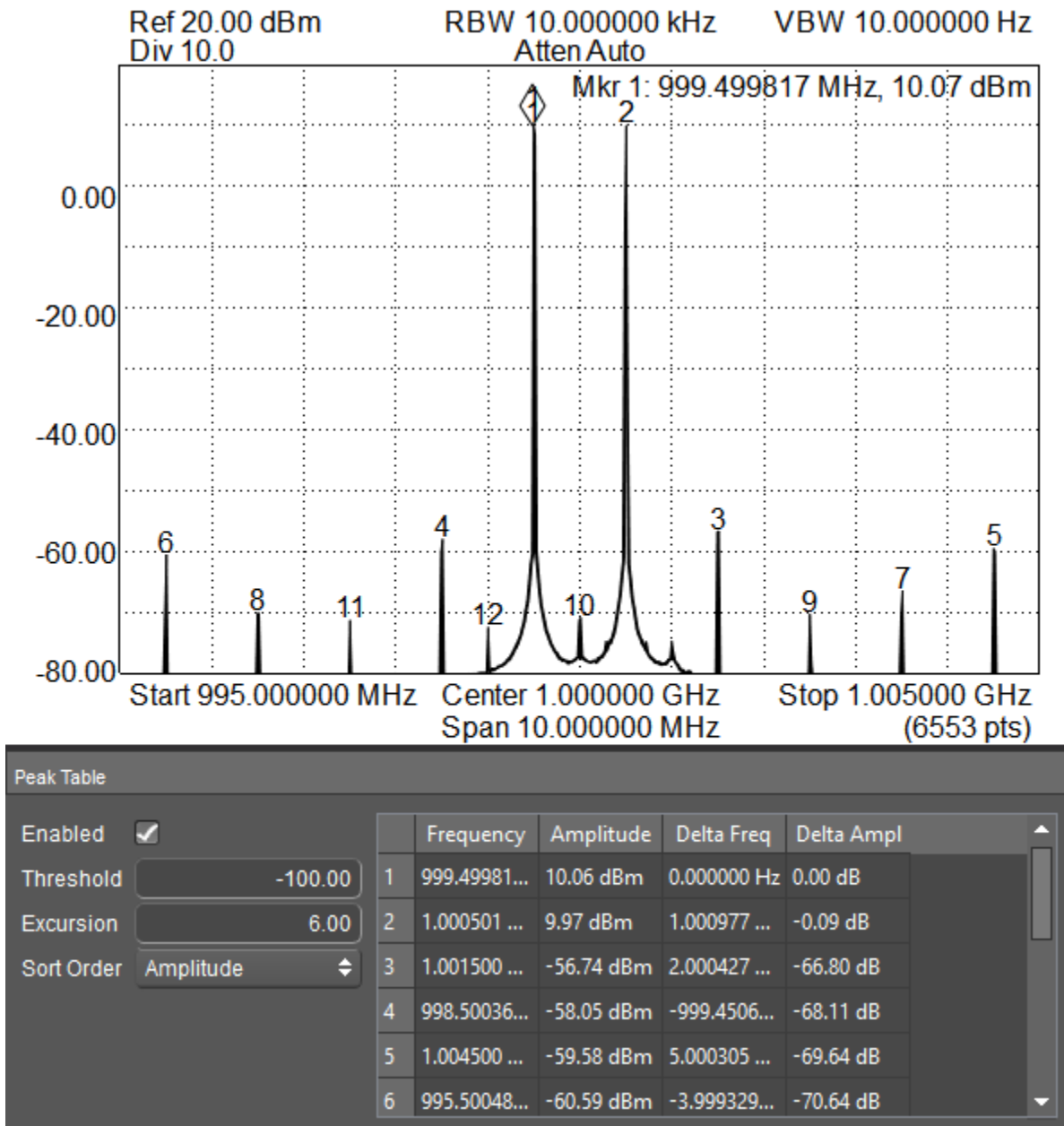

Two Tone Generation via Wilkinson Combiner

3.7 Performance over Temperature

The SynthHD Pro has an algorithm to reduce amplitude drift over temperature. The user can specify 4 different control settings in the firmware.

- 0) No temperature compensation
- 1) Compensation only during a frequency or amplitude setting
- 2) #1 plus periodic adjustments every 1 second
- 3) #1 plus periodic adjustments every 10 seconds (factory default)

Temperature compensation 2 and 3 are turned off during active modulation. Frequency sweeps and hops are only compensated for each step unless the setting is 0.

All subsequent temperature plots are based on an internal temperature measurement with temperature compensation turned ON. When the SynthHD has one RF channel turned on in a lab environment with moderate air flow at 25°C the internal temperature will usually be around 40°C.

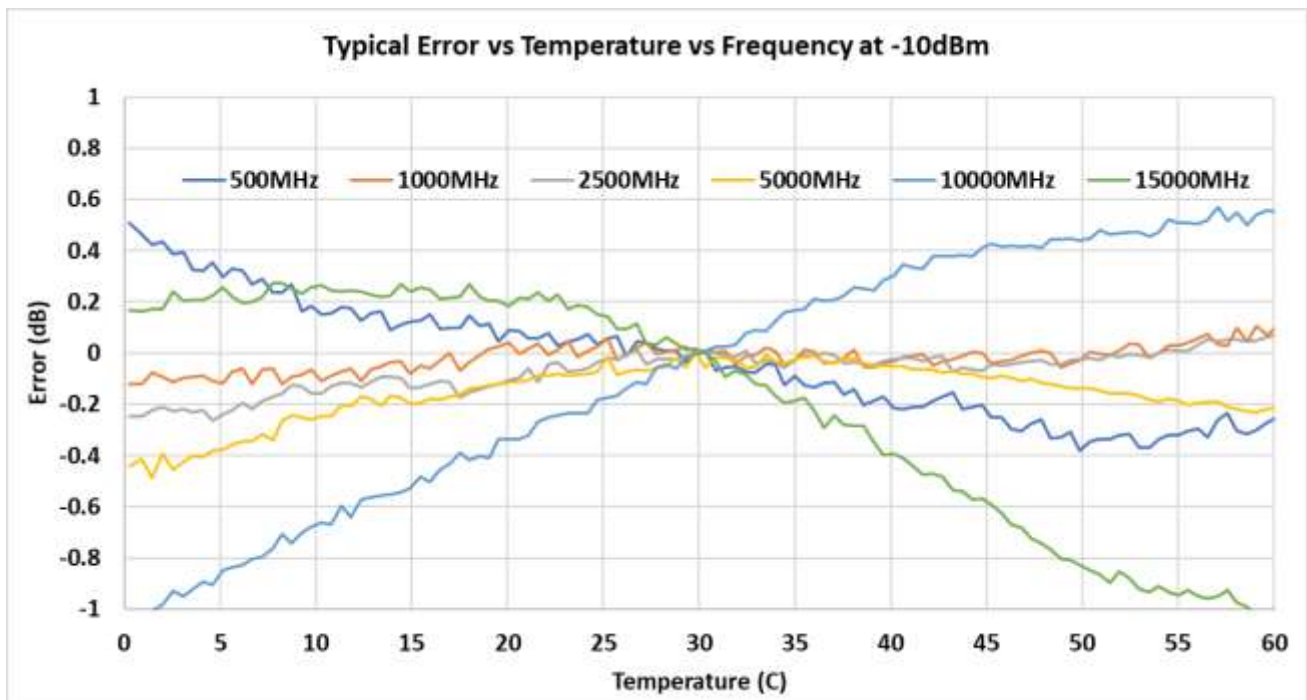

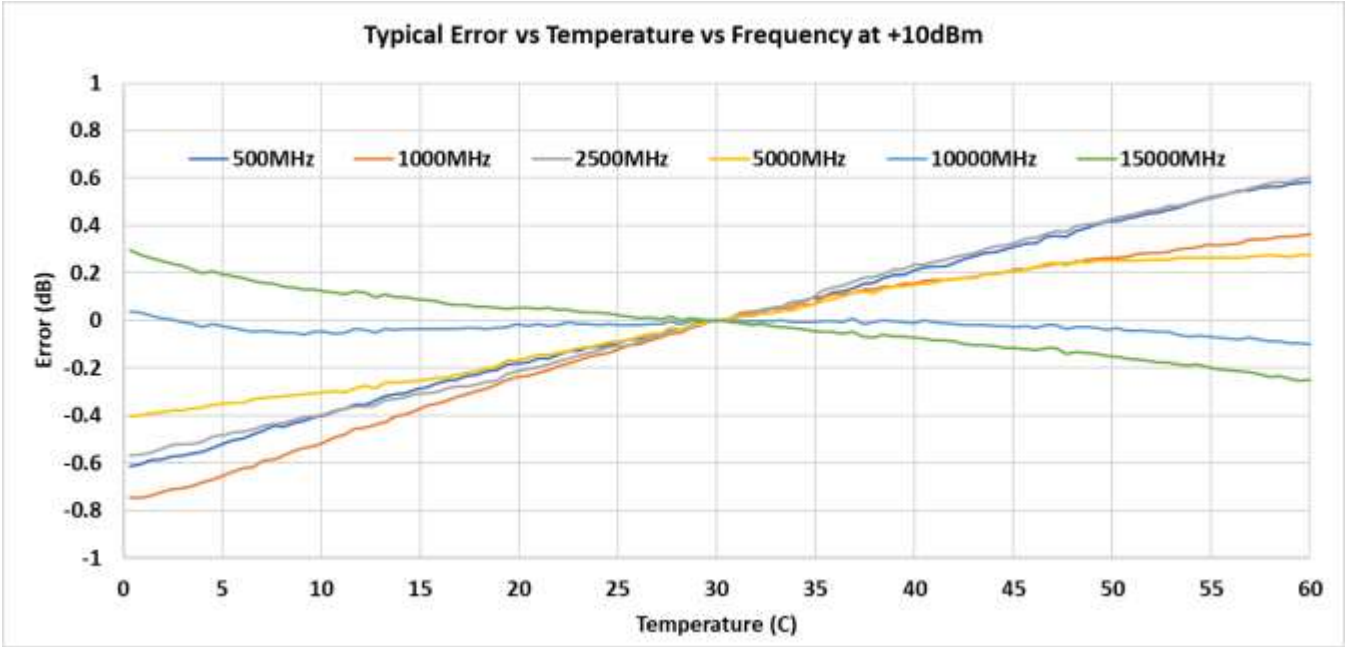
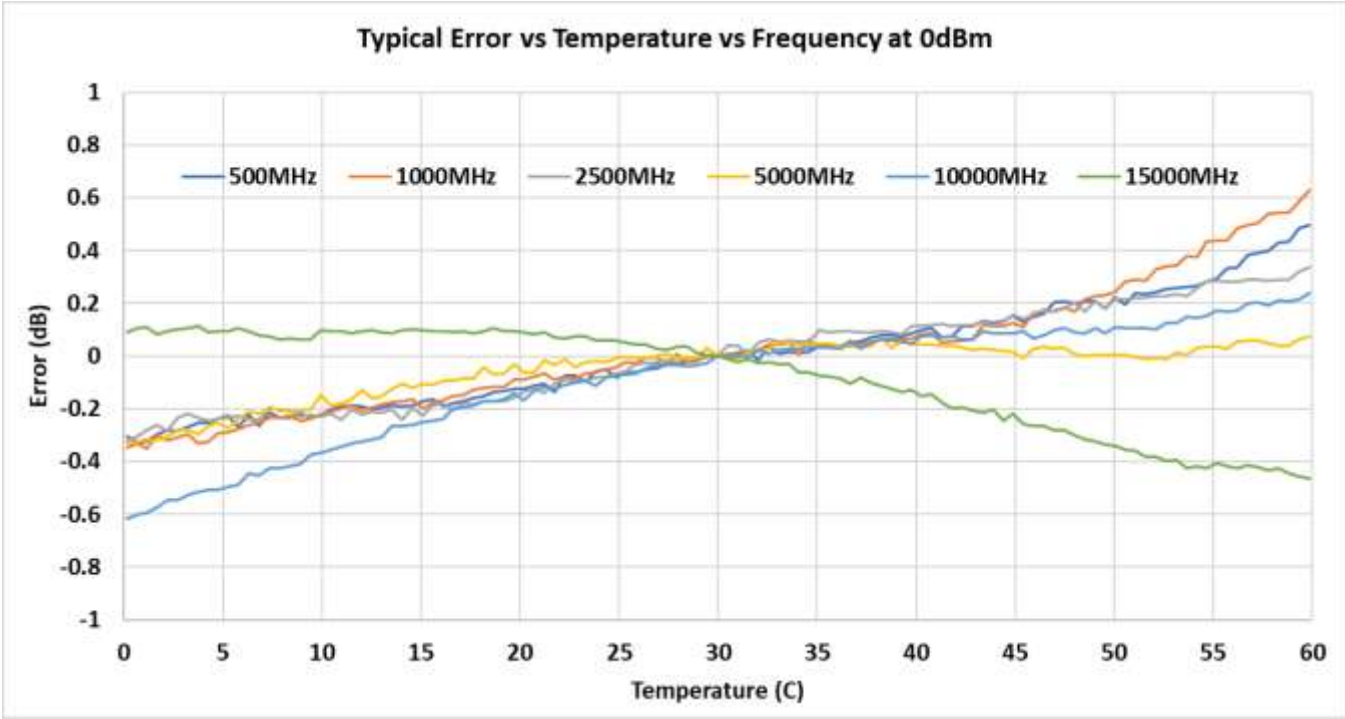

4 Device Information

4.1 Mechanical Dimensions

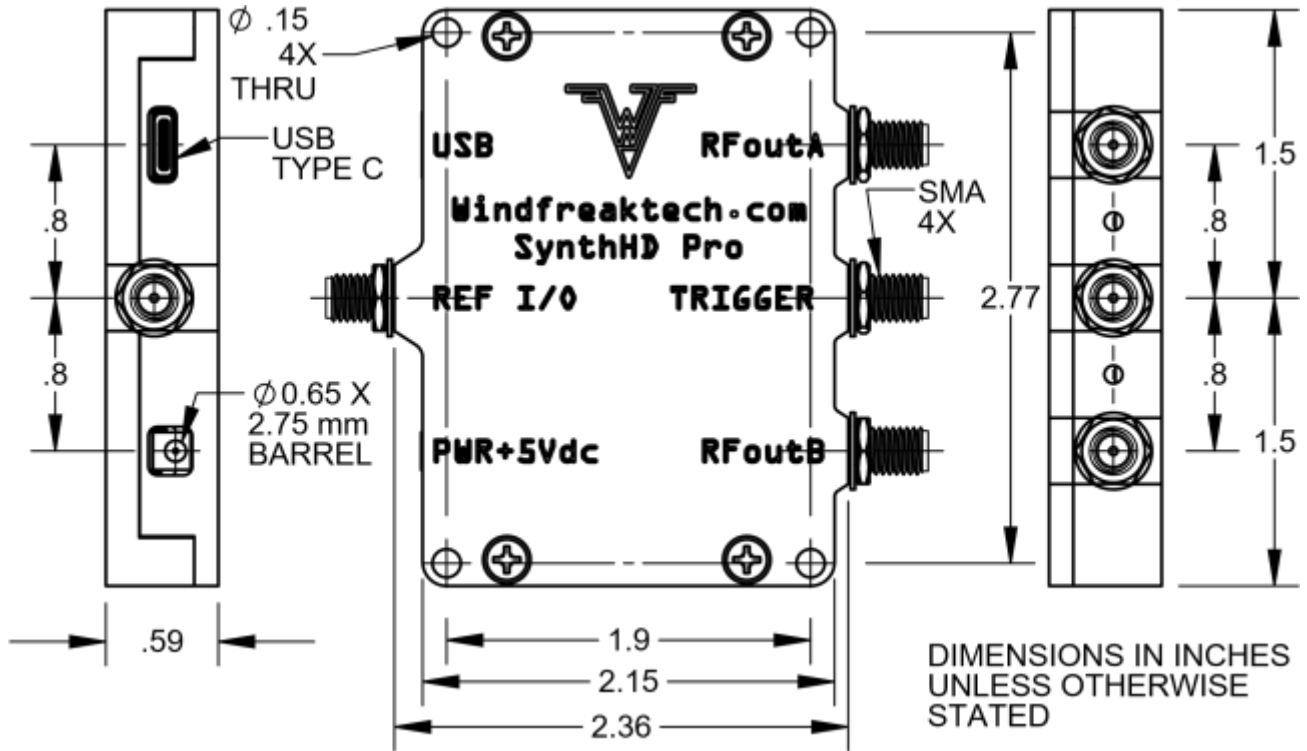

4.2 Product Renderings



Top USB Side

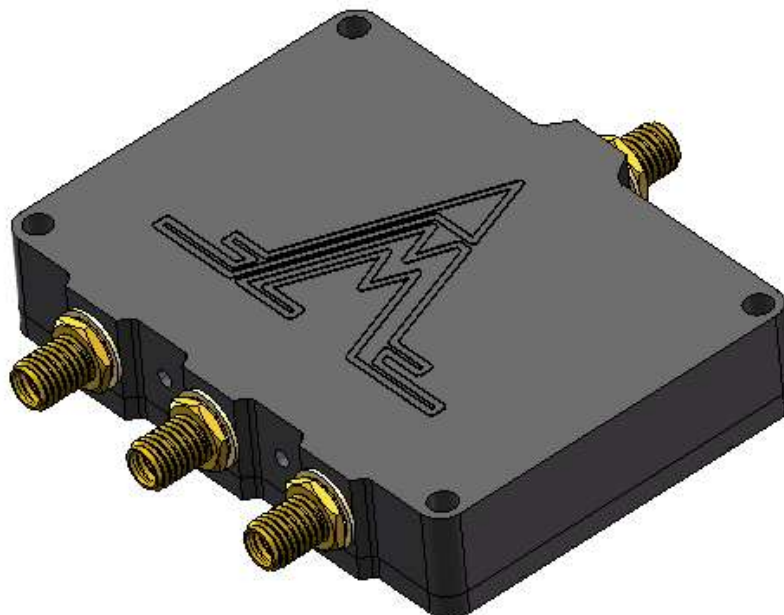

Bottom RF Side

