

## 10 MHz – 15 GHz RF Signal Generator

### Features

- Calibrated RF output
- Ultra-small, milled enclosure
- Open source Labview GUI software control
- Run hardware functions with or without a PC
- USB or UART control via USBC connector
- Trigger, Modulation via USBC connector
- Reference Input or Output via USBC
- Open source USB breakout board sold separately
- 0.01dB amplitude resolution
- 0.01Hz frequency resolution
- 100uS RF lock time standard
- 250uS per step typical sweep speed
- Up to +20dBm output power
- Over 30dB of power control
- 2.5ppm internal reference accuracy
- -115dBc/Hz phase noise at 1GHz @ 10KHz offset
- Internal and External FM, AM, Pulse Modulation
- External sweep, step and modulation trigger
- 500 point frequency and amplitude hop table
- 32-bit ARM processor on board
- Low Power 400mA typical
- Designed, manufactured, and supported in the USA

### Applications

- Wireless communications systems
- RF and Microwave radios
- Software Defined Radio (SDR)
- Radar
- Automated Test Equipment (ATE)
- EMC - radiated immunity pre-compliance testing
- Electronic Warfare (EW) and Law Enforcement
- Quantum computing and device research
- Plasma physics
- Medical research and treatment

### Overview Description

The Windfreak Technologies SynthHD Mini is a 10 MHz to 15 GHz software tunable RF signal generator and frequency sweeper controlled and powered by a device running Windows, Linux or Android via its USB port. The SynthHD Mini also has nonvolatile on-board flash memory so it can be programmed to fire up by itself on any frequency, power, sweep or modulation setting (and combinations thereof) to run without a PC in the field. This makes for a highly mobile, low power and light weight solution for your RF signal generation needs.



## Contents

<b>1</b>	<b>USB / UART WARNING .....</b>	<b>2</b>
<b>2</b>	<b>Characteristics.....</b>	<b>3</b>
2.1	Electrical Characteristics .....	3
2.2	Thermal Operating Characteristics .....	3
<b>3</b>	<b>Software and Hardware.....</b>	<b>4</b>
3.1	Open Source Software GUI.....	4
3.2	USBC Connector Pinout.....	4
3.3	Recommended UART / Trigger Breakout Circuit.....	5
<b>4</b>	<b>Typical Performance .....</b>	<b>6</b>
4.1	RF Output Power.....	6
4.2	RF Output Harmonic Content .....	7
4.3	Integer Boundary Spurs.....	8
4.4	Phase Noise and Jitter .....	9
<b>5</b>	<b>Device Information .....</b>	<b>12</b>
5.1	Mechanical Dimensions (1.6" X 1.6" X 0.48" milled aluminum case).....	12

## 1 USB / UART WARNING

The SynthHD Mini was designed to work with a USB 2 port, or a USB 2 cable which can be plugged into either a USB 2 or USBC port. Use a USB 3 cable only when tapping into the Power, UART, Reference and Trigger signals for 3.3V – 5V COM port control of the SynthHD Mini with your own microcontroller circuit. Using a USB 3 cable attached to a USB 3 port on a PC may have unknown consequences as the PC is not designed to see the SynthHD Mini UART and other signals and vv. See UART app note for UART usage instructions.

A USB 2 to USB 3 breakout adapter board is available for easier access to the UART and Trigger / Modulation connections.

UART and Trigger signals are isolated with series 500 ohm resistors to protect hardware.

## 2 Characteristics

### 2.1 Electrical Characteristics

Characteristic	Notes	Min.	Typ.	Max.	Unit
Supply Voltage	Suggested 300mA minimum	4.7	5	5.5	V
Supply Current	0dBm RF at 1GHz		400		mA
Standby Supply Current	RF output OFF		20		mA
RF Output Frequency Range		10	-	15000	MHz
Calibrated Frequency Range		10		15000	MHz
RF Output Power Maximum	See graph		20		dBm
RF Output Power Minimum	See graph		-13		dBm
RF OFF Output Power	100% shutdown of RF section			-80	dBm
RF Output Frequency Resolution	Default is 0.1Hz selectable by Channel Spacing Setting	0.01			Hz
RF Output Power Resolution		0.01			dB
Output Temperature Variation	0 to +70C, 1GHz, 0dBm		+/- 0.6		dB
RF Output Impedance			50		$\Omega$
Internal Reference Frequency			27		MHz
Internal Reference Tolerance			2.5		ppm
Trigger	Internally pulled up 5V tolerant	-0.3	3.3	5.0	V
UART	3.3V native, 5V tolerant	-0.3	3.3	5.0	V
RF Connector	Normally Polarized Female SMA				
Weight			40		g

### 2.2 Thermal Operating Characteristics

Description	Notes	Min	Max	Unit
Operating Temperature	Without airflow or heatsinking	-40	30	$^{\circ}\text{C}$
Operating Temperature	Query internal temperature sensor with software and keep below 75C with airflow, heat sinking or limited duty cycle.	-40	75 Internal	$^{\circ}\text{C}$

### 3 Software and Hardware

#### 3.1 Open Source Software GUI

The included GUI is written in LabVIEW™ and source code vi's are supplied with purchase of hardware. Also supplied is a Windows installer for users that do not own the LabVIEW™ development environment. All functions of the hardware are accessible by the software. Custom software developers see the windfreaktech.com website for a download of the easy to use API document.



#### 3.2 USBC Connector Pinout

The USBC connector is used in an unconventional way to allow access to UART, Reference, Modulation and Trigger Signals. As mentioned above, avoid connecting this device directly to a USB 3 port on your PC. Use a USB 2 extension cable instead.

Signal Name	USBC Pin #	Description
VBUS	A4, B4, A9, B9	+5V Power
USB D-	A7, B7	USB 2.0 differential pair
USB D+	A6, B6	
GND	A1, B1, A12, B12	Ground
UART Tx	A11, B11	UART SynthHD Mini TX (hook to host RX)
UART Rx	A10, B10	UART SynthHD Mini RX (hook to host TX)
Reference	A2	Reference I/O (Warning: Single Sided)
Trigger	B2	Trigger Input (Warning: Single Sided)

### 3.3 Recommended UART / Trigger Breakout Circuit

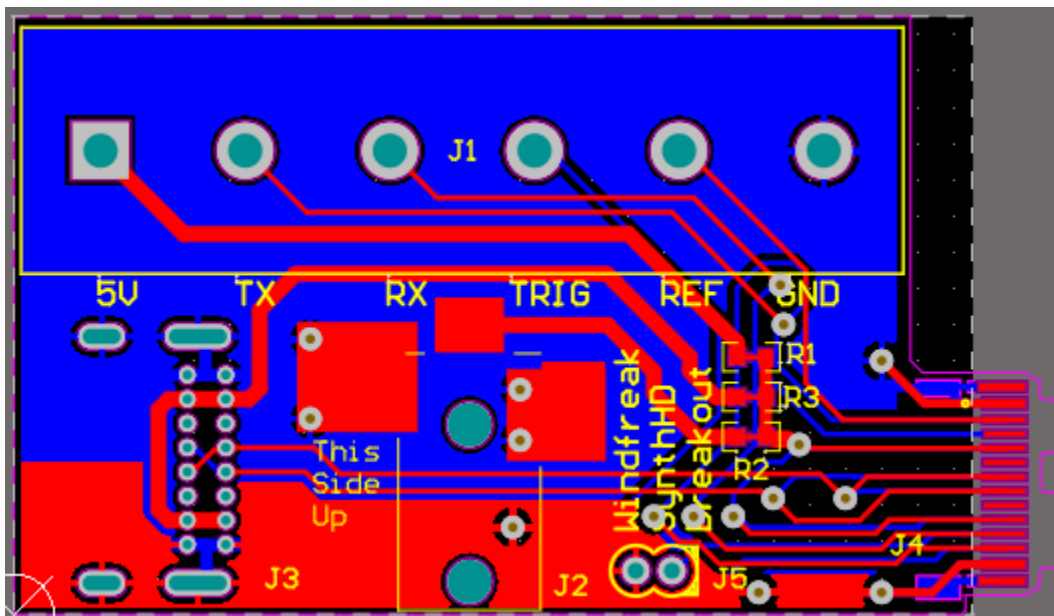
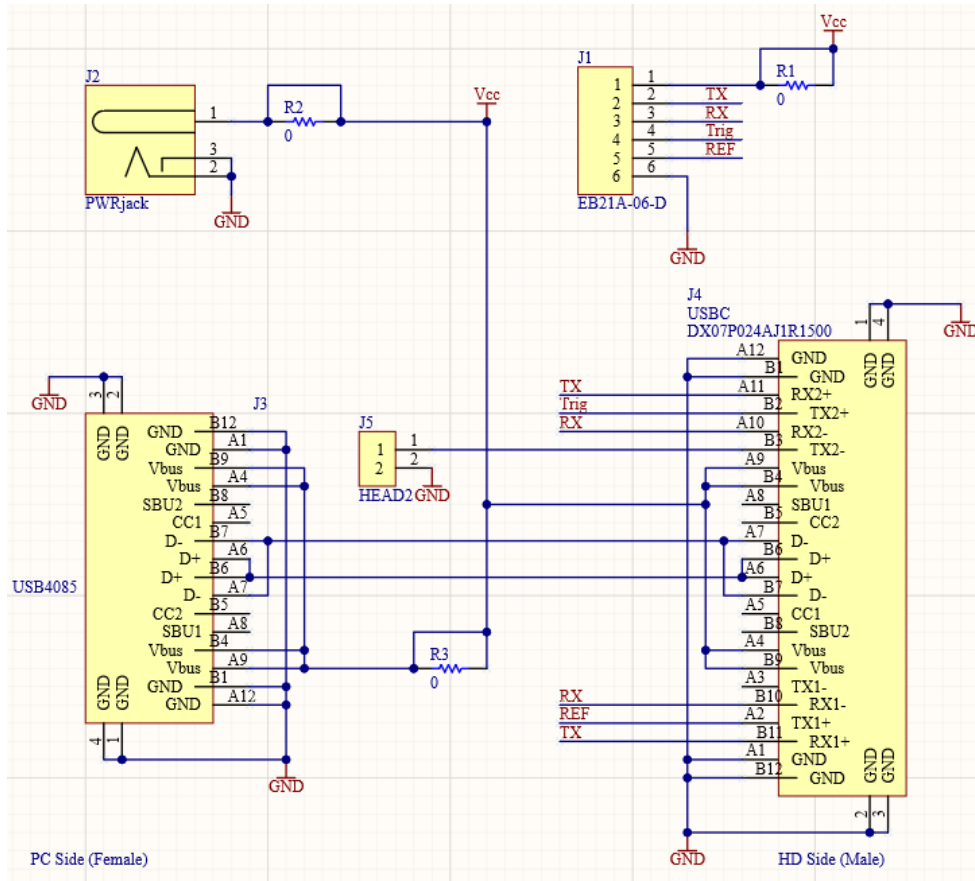

## 4 Typical Performance

### 4.1 RF Output Power

The typical maximum and minimum output power of the SynthHD Mini is shown below. This graph is of unlevelled operation at the maximum and minimum RF power settings.

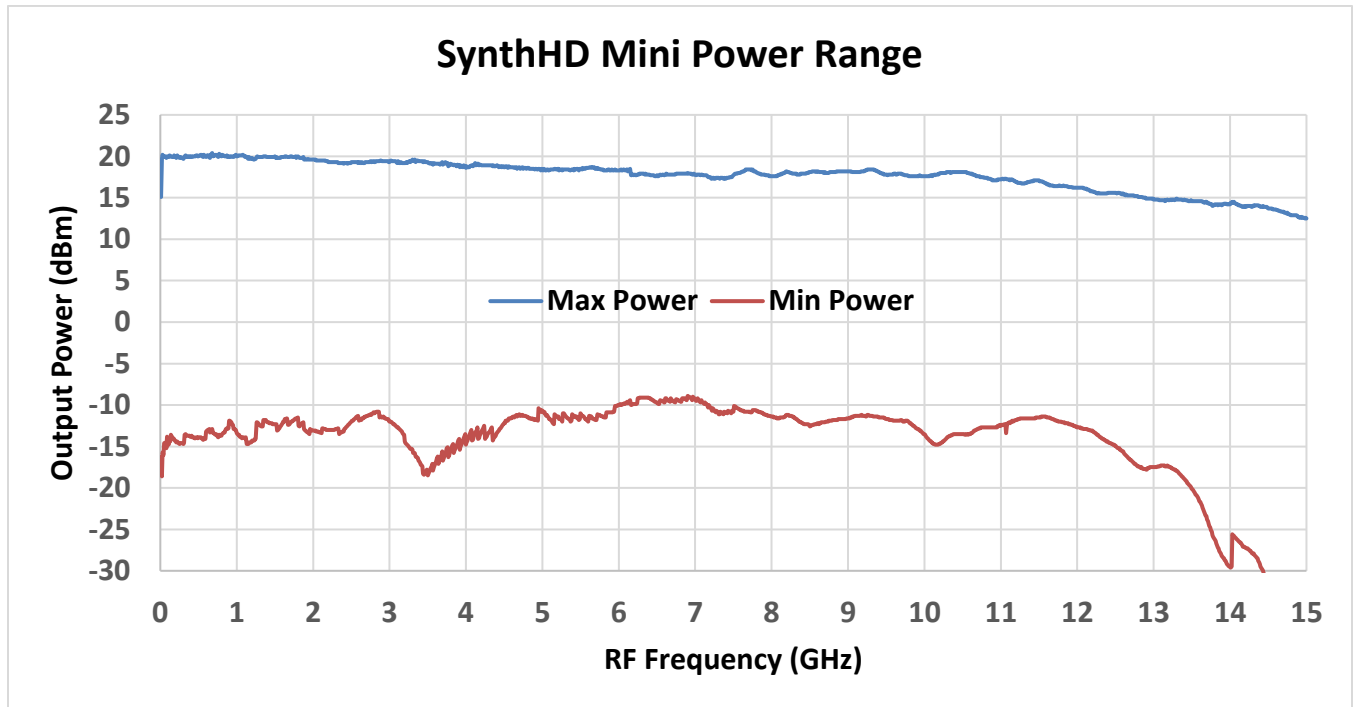

Power levels are settable in 0.01dBm increments via software. On board calibration is attained through a look up table unique to each device. Device calibration is performed at the factory and stored in onboard flash memory.

## SynthHD Mini Calibration Performance 10 MHz - 15 GHz

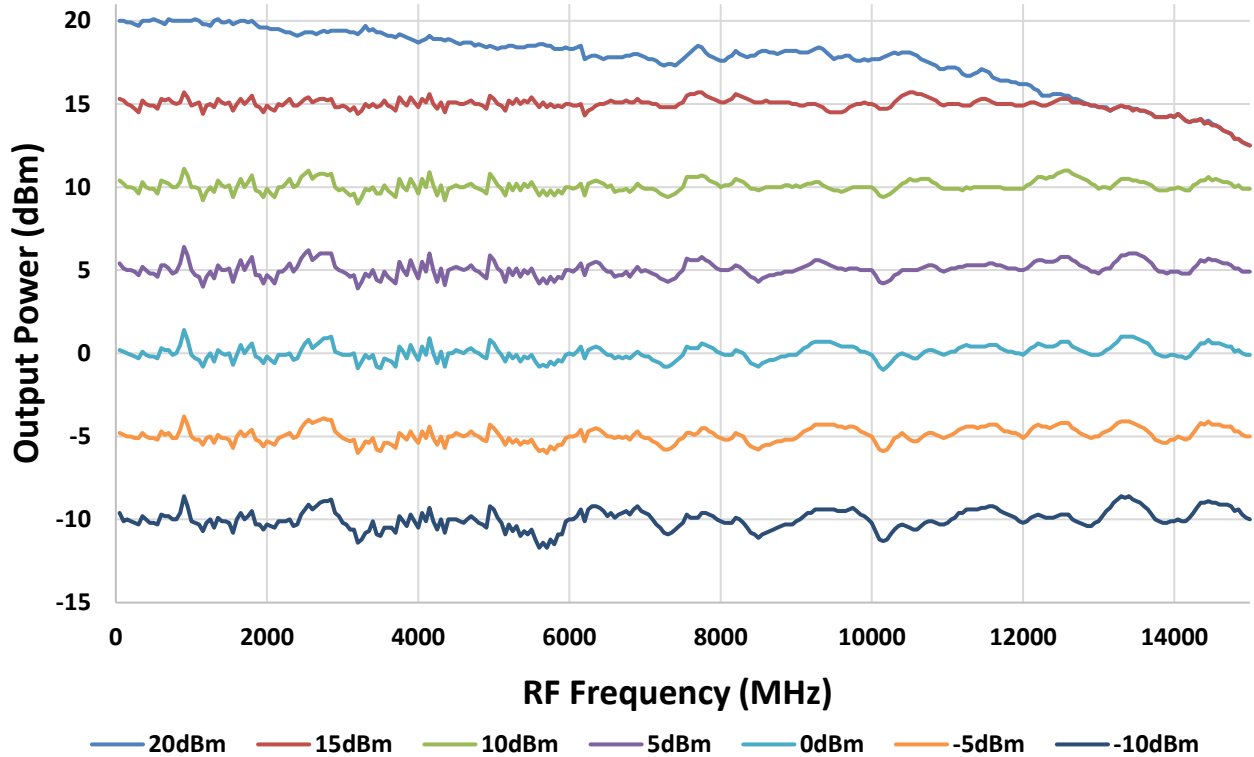

### 4.2 RF Output Harmonic Content

The typical SynthHD Mini harmonic distortion is shown below. This data is taken at a leveled fundamental power of 10dBm.

If lower harmonic levels are needed, Windfreak Technologies suggest the use of low cost SMA filters from Crystek and Minicircuits.

Example: Crystek Lowpass Filter – many cutoff frequencies, 1GHz example: CLPFL-1000, \$25

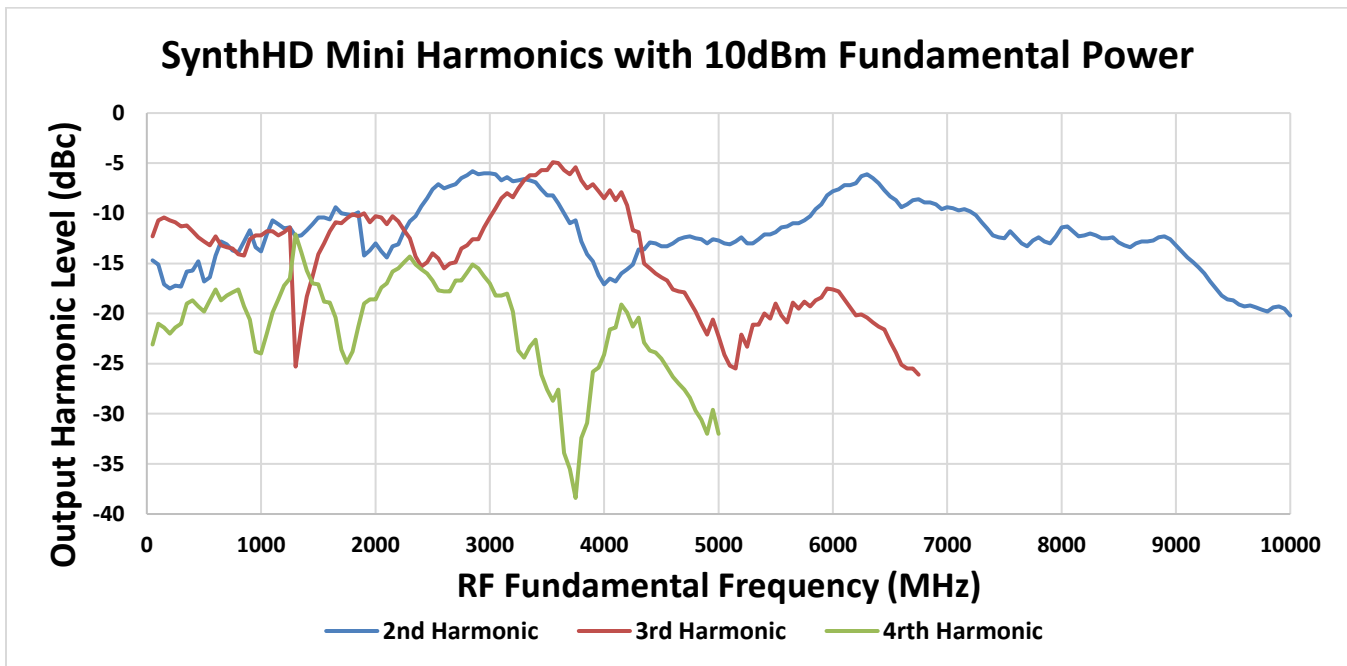

### 4.3 Integer Boundary Spurs

A mechanism for in band fractional spur creation in all fractional PLL's is the interactions between the RF VCO frequency and the internal 27MHz reference frequency. When these frequencies are not integer related, spur sidebands appear on the VCO output spectrum at an offset frequency that corresponds to the difference in frequency between an integer multiple of the reference and the VCO frequency. These spurs are attenuated when outside the loop filter which is roughly 50KHz wide.

**Example if using the SynthHD Mini 27MHz internal reference:** For the fundamental VCO range of 7500MHz to 15000MHz the first integer boundary happens at  $27\text{MHz} \times 278 = 7506\text{MHz}$ , the next at  $27\text{MHz} \times 279 = 7533\text{MHz}$  and every 27MHz thereafter up to 15000MHz. Below the fundamental VCO band the spacing will be affected by the RF divider.

A typical case generating 7506.04MHz would give integer boundary spurs at a 40KHz offset at around 37dBc. A typical case generating 7506.40MHz would give integer boundary spurs at a 400KHz offset at around 58dBc. (These were measured with the reference doubler off and PLL ICP set at 5).



## 4.4 Phase Noise and Jitter

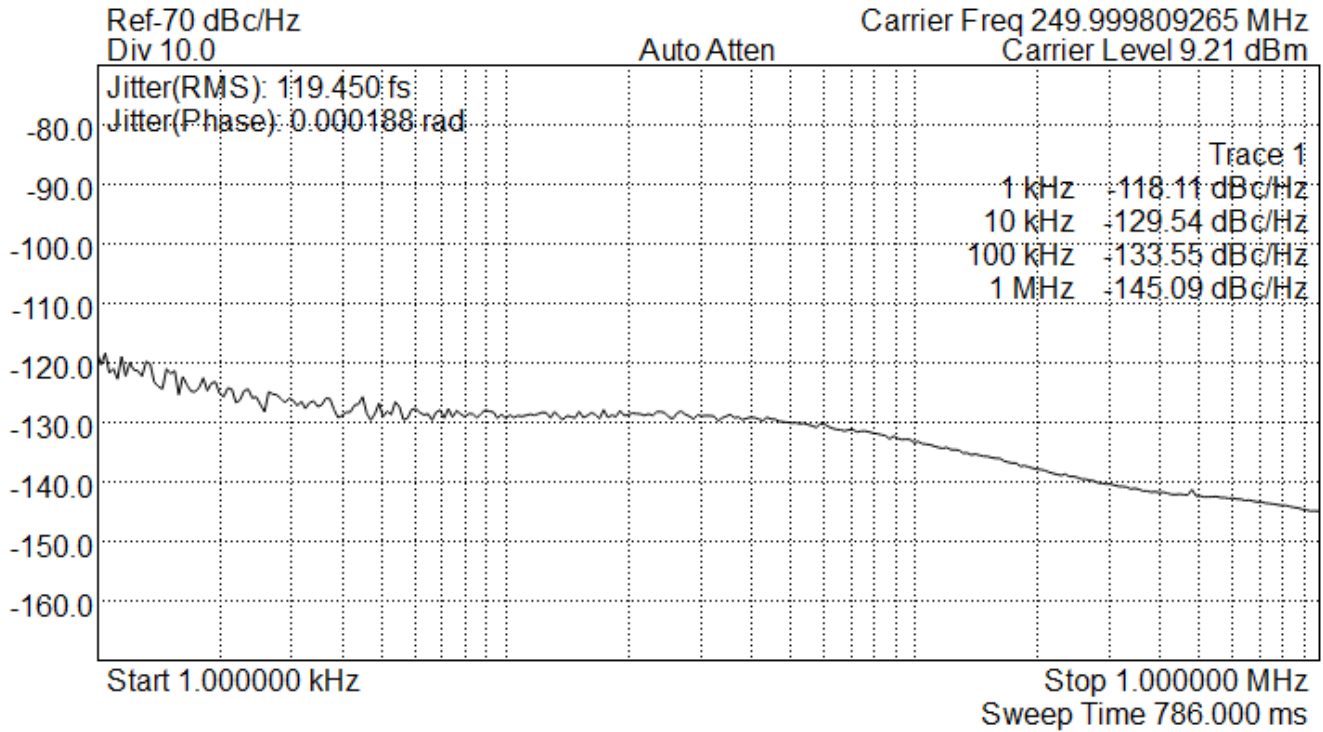

250MHz Phase Noise (27MHz Internal Reference with REF Doubler Enabled)

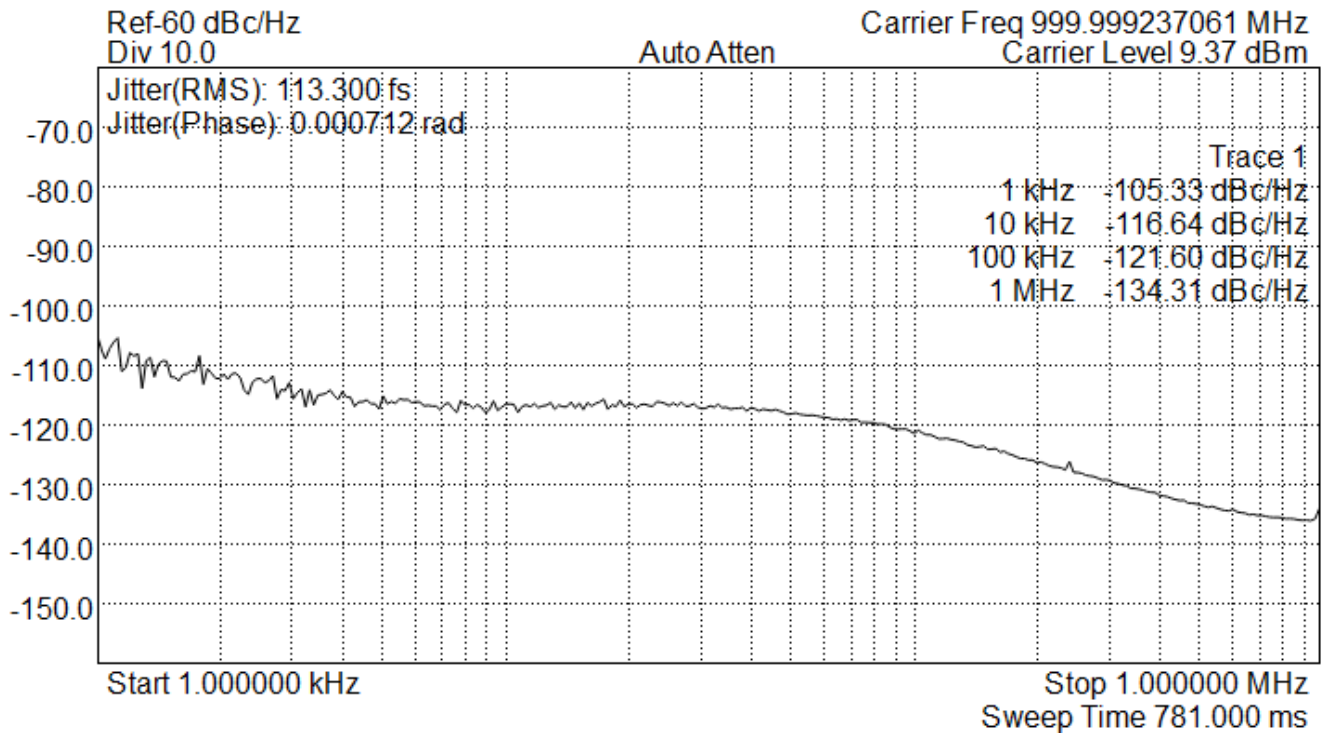

1GHz Phase Noise (27MHz Internal Reference with REF Doubler Enabled)

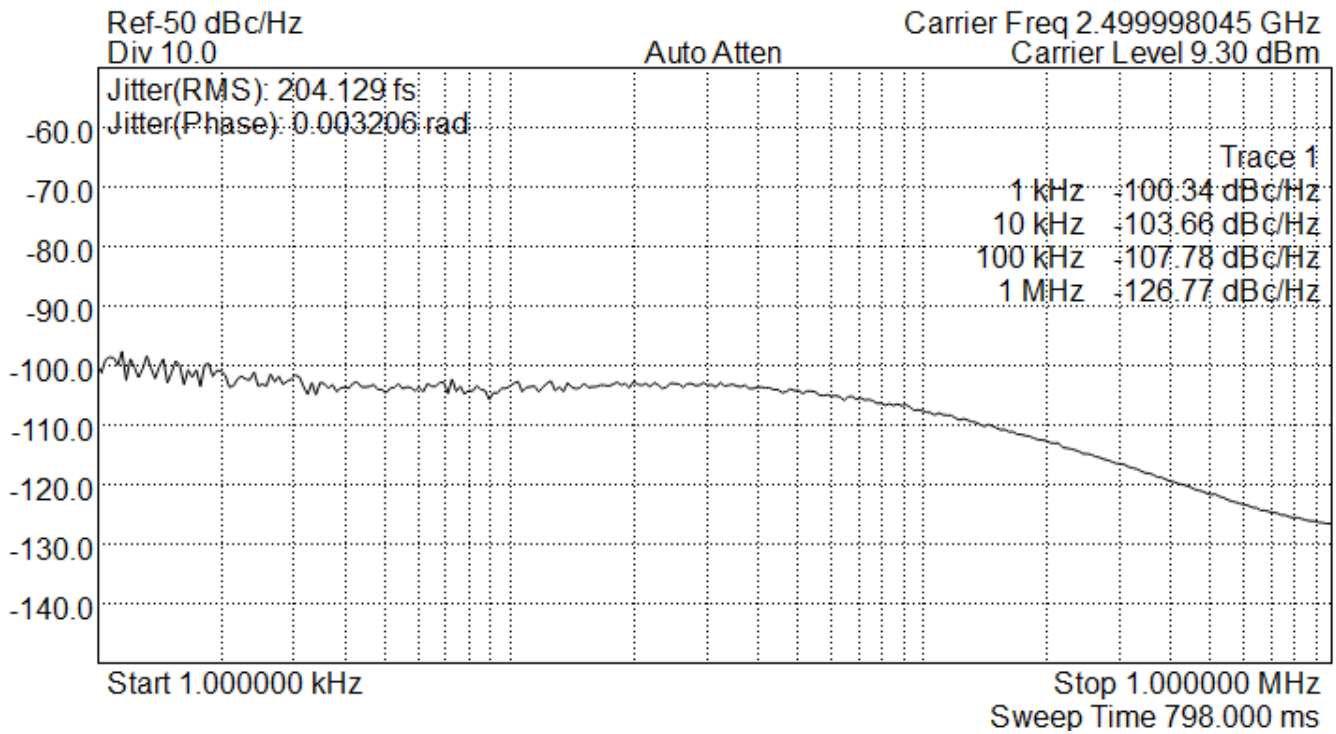

2.5GHz Phase Noise (27MHz Internal Reference with REF Doubler Enabled)

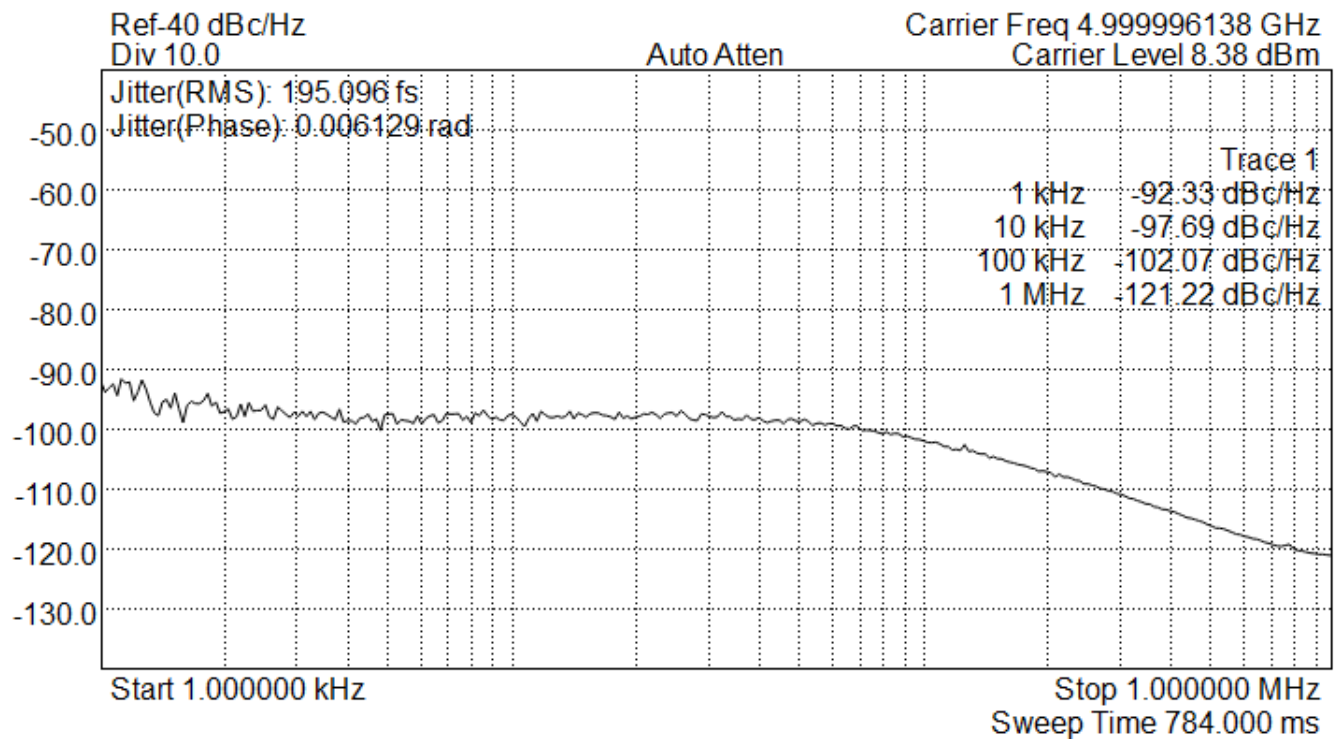

5GHz Phase Noise (27MHz Internal Reference with REF Doubler Enabled)

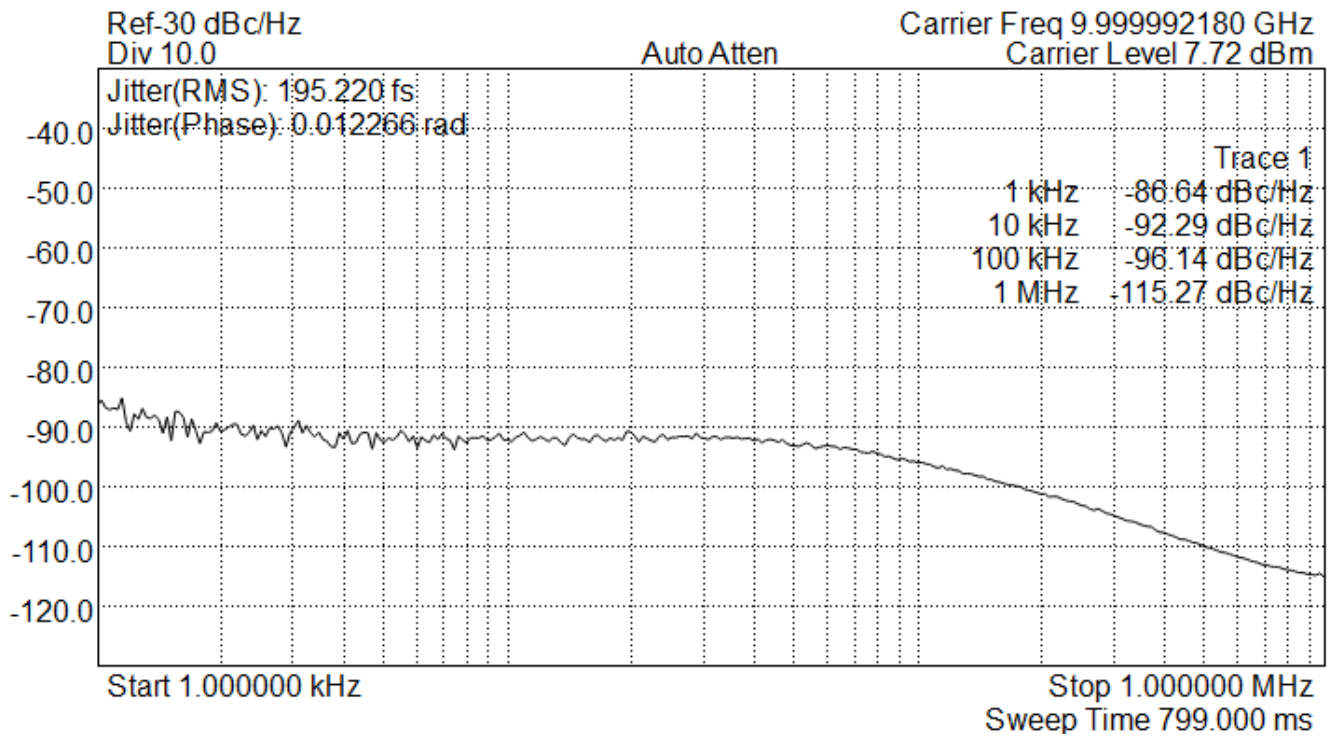

10GHz Phase Noise (27MHz Internal Reference with REF Doubler Enabled)

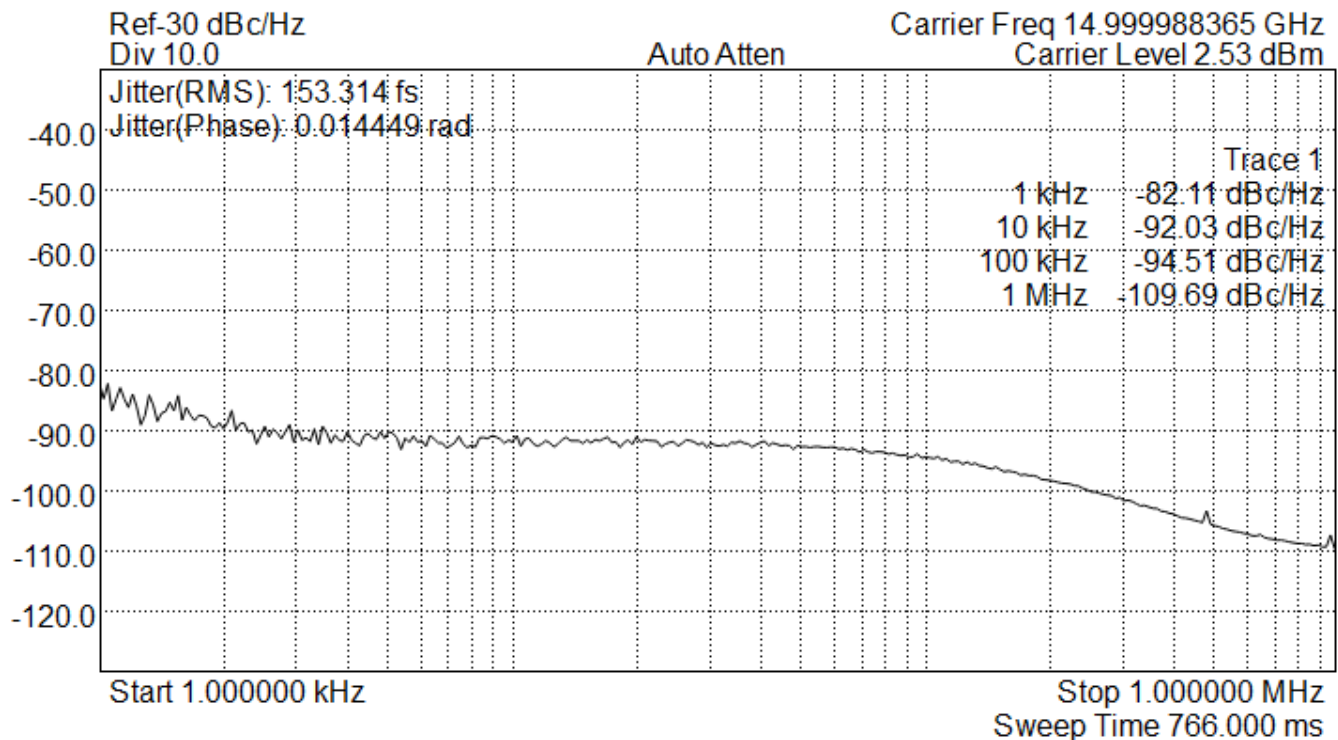

15GHz Phase Noise (27MHz Internal Reference with REF Doubler Enabled)

## 5 Device Information

### 5.1 Mechanical Dimensions (1.6" X 1.6" X 0.48" milled aluminum case)

